

Foams, Polytopes, Abstract Tensors, and Homology

J. Scott Carter

University of South Alabama

Moscow, July 2017

Acknowledgements

1. Thanks to organizers

Acknowledgements

1. Thanks to organizers
2. Collaboration with A. Ishii, K. Tanaka, and M. Saito

Acknowledgements

1. Thanks to organizers
2. Collaboration with A. Ishii, K. Tanaka, and M. Saito
3. This version : conversations with J. Przytycki, S. Y. Yang, J. Vicary, and B. Bartlett.

Acknowledgements

1. Thanks to organizers
2. Collaboration with A. Ishii, K. Tanaka, and M. Saito
3. This version : conversations with J. Przytycki, S. Y. Yang, J. Vicary, and B. Bartlett.
4. Initial support Ministry of Education Science and Technology (MEST) and the Korean Federation of Science and Technology Societies (KOFST).

Acknowledgements

1. Thanks to organizers
2. Collaboration with A. Ishii, K. Tanaka, and M. Saito
3. This version : conversations with J. Przytycki, S. Y. Yang, J. Vicary, and B. Bartlett.
4. Initial support Ministry of Education Science and Technology (MEST) and the Korean Federation of Science and Technology Societies (KOFST).
5. Current funding: Simons Foundation.

Section 1

in which systems of abstract tensor equations are formulated and a solution is proposed.

3D moves

$$\langle a, b \rangle + \langle ab, c \rangle = \langle b, c \rangle + \langle a, bc \rangle$$

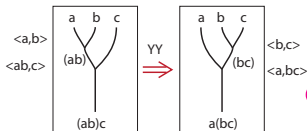

$$\langle a \rangle \langle b \rangle + \langle a^*b \rangle \langle c \rangle + \langle b, c \rangle = \langle b, c \rangle + \langle a \rangle \langle bc \rangle$$

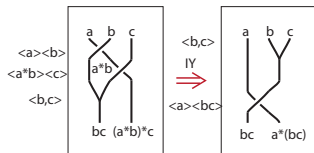
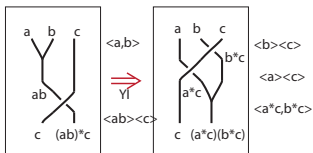

$$\langle a, b \rangle + \langle ab \rangle \langle c \rangle = \langle b \rangle \langle c \rangle + \langle a \rangle \langle c \rangle + \langle a^*c, b^*c \rangle$$

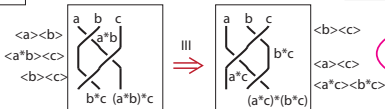

$$\langle a \rangle \langle b \rangle + \langle a^*b \rangle \langle c \rangle = \langle a \rangle \langle c \rangle + \langle a^*c \rangle \langle b^*c \rangle$$

In 3-D equations

A	$Y_j^{\ell,n} Y_i^{j,k} = Y_p^{n,k} Y_i^{\ell,p}$
YI	$Y_d^{a,b} X_{e,f}^{d,c} = X_{c,h}^{b,c} X_{e,g}^{a,c} Y_f^{g,h}.$
IY	$X_{d,g}^{a,b} X_{h,f}^{g,c} Y_e^{d,h} = Y_i^{b,c} X_{e,f}^{a,i}$
III	$X_{d,e}^{a,b} X_{i,h}^{e,c} X_{f,g}^{d,i} = X_{j,k}^{b,c} X_{f,e}^{a,j} X_{g,h}^{e,k}$

Easy Solution

$$Y_c^{a,b} = \begin{cases} 1 & \text{if } c = ab, \\ 0 & \text{otherwise;} \end{cases}$$

$$X_{c,d}^{a,b} = \begin{cases} 1 & \text{if } c = b \text{ \& } d = b^{-1}ab, \\ 0 & \text{otherwise.} \end{cases}$$

4D moves

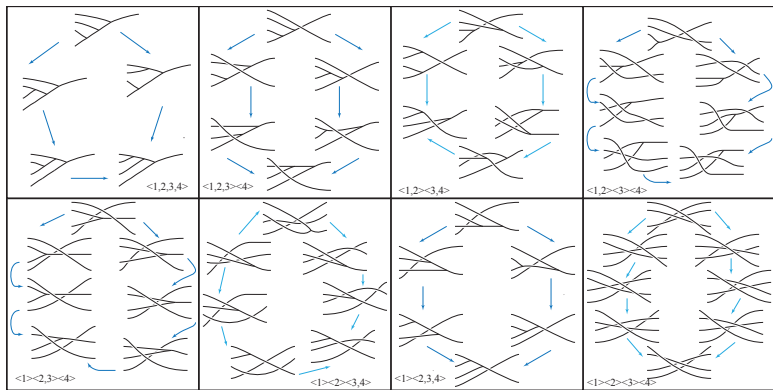

4-D Equations

YYY	$K_{p,q}^{m,n} K_{s,t}^{p,r} = K_{u,v}^{n,r} K_{s,w}^{m,u} K_{t,q}^{w,v}$
YYI	$M_{t,u,v}^{p,q} M_{x,y,z}^{u,r} K_{m,n}^{t,x} = K_{s,i}^{q,r} M_{m,y,j}^{p,s} M_{n,z,v}^{j,i}$
YY	$W_{i,j}^{p,q,r} M_{m,n,y}^{i,s} = M_{t,u,v}^{r,s} M_{m,x,z}^{q,t} W_{n,h}^{p,x,u} W_{y,i}^{h,z,v}$
YII	$\mathbb{X}_{t,x,v}^{p,q,r} M_{y,u,v}^{x,s} M_{m,n,z}^{t,i} = M_{j,x,g}^{r,s} M_{m,t,x}^{q,j} \mathbb{X}_{n,y,f}^{p,t,x} \mathbb{X}_{z,u,v}^{f,w,g}$
IYY	$K_{u,v}^{p,q} W_{i,j}^{v,r,s} W_{y,z}^{u,i,t} = W_{u,v}^{q,s,t} W_{y,i}^{p,r,u} K_{z,j}^{i,v}$
IYI	$M_{u,v,x}^{p,q} \mathbb{X}_{i,j,n}^{x,r,s} \mathbb{X}_{h,g,f}^{v,j,t} W_{y,z}^{u,i,h} = W_{u,v}^{q,s,t} \mathbb{X}_{y,i,j}^{p,r,u} M_{z,f,n}^{j,v}$
IYY	$W_{h,j}^{p,q,r} W_{i,n}^{j,s,t} \mathbb{X}_{x,y,z}^{h,i,u} = \mathbb{X}_{v,g,f}^{r,t,u} \mathbb{X}_{x,h,j}^{q,s,v} W_{y,i}^{p,h,g} W_{z,n}^{i,j,f}$
IIII	$\mathbb{X}_{v,x,y}^{p,q,r} \mathbb{X}_{z,e,n}^{y,s,t} \mathbb{X}_{k,h,j}^{x,e,u} \mathbb{X}_{g,f,i}^{v,z,k} = \mathbb{X}_{k,z,v}^{r,t,u} \mathbb{X}_{g,e,x}^{q,s,k} \mathbb{X}_{f,h,y}^{p,e,z} \mathbb{X}_{i,j,n}^{y,x,v}$

Solutions part 1

$$K_{r,s}^{p,q} = \begin{cases} 1 & \text{if } \exists a, b, c \text{ s.t.} \\ & \begin{cases} p = ((ab, c), 0|0), & q = ((a, b), 0|0), \\ r = ((a, bc), 0|0), & \& s = ((b, c), 0|0). \end{cases} \\ 0 & \text{otherwise;} \end{cases}$$

Solutions part 2

$$M_{p,q,r}^{i,j} = \begin{cases} 1 & \text{if } \exists a, b, c \text{ s.t.} \\ & \begin{cases} i = ((0, 0), ab|c), & j = ((a, b), 0|0), \\ p = ((a, b) \triangleleft c, 0|0), & q = ((0, 0), a|c), \\ \& r = ((0, 0), b|c), \end{cases} \\ 0 & \text{otherwise;} \end{cases}$$

Solutions part 3

$$W_{p,q}^{i,j,\ell} = \begin{cases} 1 & \text{if } \exists a, b, c \text{ s.t.} \\ & \begin{cases} i = ((b, c), 0|0), & j = ((0, 0), (a \triangleleft b)|c), \\ \ell = ((0, 0), a|b), \\ p = ((0, 0), a|(bc)), & \& q = ((b, c), 0|0), \end{cases} \\ 0 & \text{otherwise;} \end{cases}$$

Solutions part 4

$$\chi_{s,t,u}^{p,q,r} = \begin{cases} 1 & \text{if } \exists a, b, c \text{ s.t.} \\ & \begin{cases} p = ((0, 0), b|c), & q = ((0, 0), (a \triangleleft b)|c), \\ r = ((0, 0), a|b), \\ s = ((0, 0), (a|b) \triangleleft c), & t = ((0, 0), a|c), \\ \& u = ((0, 0), b|c), \end{cases} \\ 0 & \text{otherwise;} \end{cases}$$

where, *e.g.*, $a \triangleleft c = c^{-1}ac$, $(a, b) \triangleleft c = (a \triangleleft c, b \triangleleft c)$,
and $(a|b) \triangleleft c = (a \triangleleft c)|(b \triangleleft c)$

Algebraic setting

Let T denote a free module

Algebraic setting

Let T denote a free module (vector space)

Algebraic setting

Let T denote a free module (vector space) generated by pairs of elements (a, b)

Algebraic setting

Let T denote a free module (vector space) generated by pairs of elements (a, b) where $a, b \in G$ — a group.

Algebraic setting

Let T denote a free module (vector space) generated by pairs of elements (a, b) where $a, b \in G$ — a group. More general situation later.

Algebraic setting

Let T denote a free module (vector space) generated by pairs of elements (a, b) where $a, b \in G$ — a group. More general situation later. Read T as “together.”

Algebraic setting

Let T denote a free module (vector space) generated by pairs of elements (a, b) where $a, b \in G$ — a group. More general situation later. Read T as “together.” Let S denote the free module generated by pairs $c|d$.

Algebraic setting

Let T denote a free module (vector space) generated by pairs of elements (a, b) where $a, b \in G$ — a group. More general situation later. Read T as “together.” Let S denote the free module generated by pairs $c|d$. Also $c, d \in G$. The letter S stands for “separated.” Let $V = T \oplus S$.

Algebraic setting

Let T denote a free module (vector space) generated by pairs of elements (a, b) where $a, b \in G$ — a group. More general situation later. Read T as “together.” Let S denote the free module generated by pairs $c|d$. Also $c, d \in G$. The letter S stands for “separated.” Let $V = T \oplus S$. Subsequently, we’ll generalize this module.

So when I write, *e.g.*

$$M_{p,q,r}^{i,j} = \begin{cases} 1 \text{ if } \exists a, b, c \text{ s.t.} \\ \quad \begin{cases} i = ((0, 0), ab|c), & j = ((a, b), 0|0), \\ p = ((a, b) \triangleleft c, 0|0), & q = ((0, 0), a|c), \\ \quad \& r = ((0, 0), b|c), \end{cases} \\ 0 \text{ otherwise;} \end{cases}$$

So when I write, *e.g.*

$$M_{p,q,r}^{i,j} = \begin{cases} 1 & \text{if } \exists a, b, c \text{ s.t.} \\ & \begin{cases} i = ((0, 0), ab|c), & j = ((a, b), 0|0), \\ p = ((a, b) \triangleleft c, 0|0), & q = ((0, 0), a|c), \\ & \& r = ((0, 0), b|c), \end{cases} \\ 0 & \text{otherwise;} \end{cases}$$

the tensor M is a morph.

$$V \otimes V \xleftarrow{M} V \otimes V \otimes V.$$

In general,

$$V \otimes V \xleftarrow{\mathbf{K}} V \otimes V,$$

In general,

$$V \otimes V \xleftarrow{K} V \otimes V,$$

$$V \otimes V \xleftarrow{M} V \otimes V \otimes V,$$

In general,

$$V \otimes V \xleftarrow{K} V \otimes V,$$

$$V \otimes V \xleftarrow{M} V \otimes V \otimes V,$$

$$V \otimes V \otimes V \xleftarrow{W} V \otimes V,$$

In general,

$$V \otimes V \xleftarrow{K} V \otimes V,$$

$$V \otimes V \xleftarrow{M} V \otimes V \otimes V,$$

$$V \otimes V \otimes V \xleftarrow{W} V \otimes V,$$

and

$$V \otimes V \otimes V \xleftarrow{X} V \otimes V \otimes V.$$

I soon want to given the geometric background for these equations, and point out that,

I soon want to given the geometric background
for these equations, and point out that, as usual,

I soon want to give the geometric background for these equations, and point out that, as usual, these systems of equations generalize immediately to all dimensions, and in an appropriate algebraic context, we can find solutions.

Section 2

First, foams are used to describe the categorifications of sl_3 invariants of classical knots.

Section 2

First, foams are used to describe the categorifications of sl_3 invariants of classical knots. Those foams are related to,

Section 2

First, foams are used to describe the categorifications of sl_3 invariants of classical knots. Those foams are related to, but not identical to,

Section 2

First, foams are used to describe the categorifications of sl_3 invariants of classical knots. Those foams are related to, but not identical to, the foams considered here.

Section 2

First, foams are used to describe the categorifications of sl_3 invariants of classical knots. Those foams are related to, but not identical to, the foams considered here. I'll describe and illustrate local crossings of n -foams.

The Space Y^n

Let $\Delta^{n+1} = \{\vec{x} \in \mathbb{R}^{n+2} : \sum x_i = 1 \text{ \& } 0 \leq x_i\}$
denote the standard simplex.

The Space Y^n

Let $\Delta^{n+1} = \{\vec{x} \in \mathbb{R}^{n+2} : \sum x_i = 1 \text{ \& } 0 \leq x_i\}$
denote the standard simplex. The space
 $Y^n \subset \Delta^{n+1}$ is defined as follows:

The Space Y^n

Let $\Delta^{n+1} = \{\vec{x} \in \mathbb{R}^{n+2} : \sum x_i = 1 \text{ \& } 0 \leq x_i\}$
denote the standard simplex. The space
 $Y^n \subset \Delta^{n+1}$ is defined as follows: $Y^0 = (\frac{1}{2}, \frac{1}{2})$.

The Space Y^n

Let $\Delta^{n+1} = \{\vec{x} \in \mathbb{R}^{n+2} : \sum x_i = 1 \text{ \& } 0 \leq x_i\}$
denote the standard simplex. The space
 $Y^n \subset \Delta^{n+1}$ is defined as follows: $Y^0 = (\frac{1}{2}, \frac{1}{2})$.
Take $\Delta_j^n = \{\vec{x} \in \Delta^{n+1} : x_j = 0\}$.

The Space Y^n

Let $\Delta^{n+1} = \{\vec{x} \in \mathbb{R}^{n+2} : \sum x_i = 1 \text{ \& } 0 \leq x_i\}$
denote the standard simplex. The space
 $Y^n \subset \Delta^{n+1}$ is defined as follows: $Y^0 = (\frac{1}{2}, \frac{1}{2})$.
Take $\Delta_j^n = \{\vec{x} \in \Delta^{n+1} : x_j = 0\}$. Embed a copy,
 $Y_j^{n-1} \subset \Delta_j^n$.

The Space Y^n

Let $\Delta^{n+1} = \{\vec{x} \in \mathbb{R}^{n+2} : \sum x_i = 1 \text{ \& } 0 \leq x_i\}$
denote the standard simplex. The space
 $Y^n \subset \Delta^{n+1}$ is defined as follows: $Y^0 = (\frac{1}{2}, \frac{1}{2})$.
Take $\Delta_j^n = \{\vec{x} \in \Delta^{n+1} : x_j = 0\}$. Embed a copy,
 $Y_j^{n-1} \subset \Delta_j^n$. Cone $\cup_{j=1}^{n+2} Y_j^{n-1}$ to the barycenter
 $b = \frac{1}{n+2}(1, 1, \dots, 1)$ of Δ^{n+1} .

$$Y^n = C \left(\cup_{j=1}^{n+2} Y_j^{n-1} \right).$$

The space Y^2

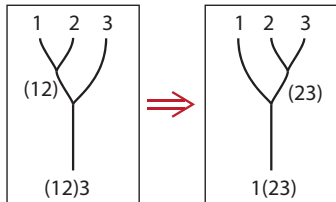
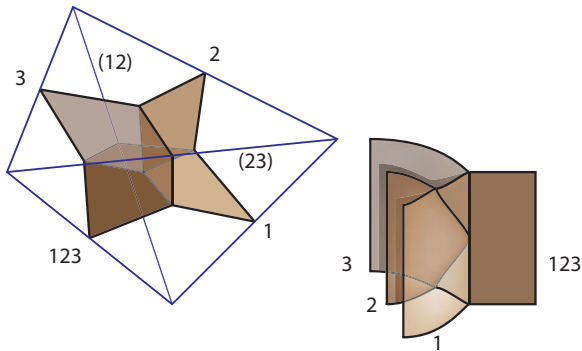

The space Y^3

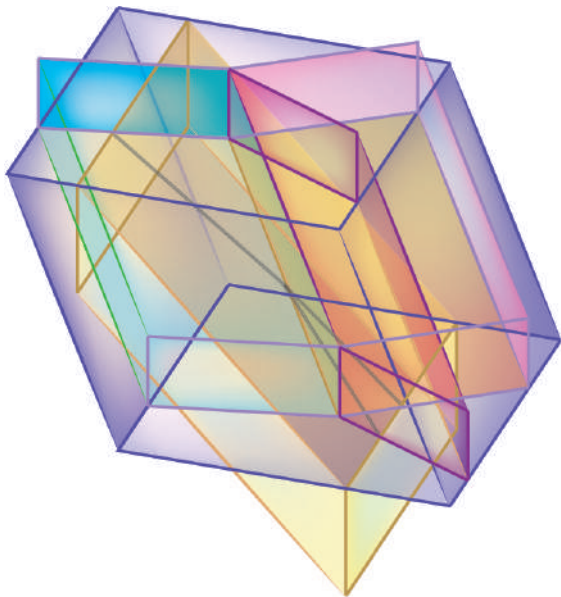

Foam Definition

An n -**dimensional foam** is a compact top. sp. X for which each point $x \in X$ has a nbhd. $N(x)$ that is homeom. to a nbhd. M of a point in Y^n .

Local pictures of crossings

Now take

$$\left[\bigcup_{\ell=1}^k (\Delta^{j_1} \times \cdots \times Y^{j_{\ell-1}} \times \cdots \times \Delta^{j_k}) \subset \mathbb{R}^{n+1} \times \{\ell\} \right],$$

Local pictures of crossings

Now take

$$\left[\bigcup_{\ell=1}^k (\Delta^{j_1} \times \cdots \times Y^{j_{\ell-1}} \times \cdots \times \Delta^{j_k}) \subset \mathbb{R}^{n+1} \times \{\ell\} \right],$$

and project this into \mathbb{R}^{n+1} .

Local pictures of crossings

Now take

$$\left[\bigcup_{\ell=1}^k (\Delta^{j_1} \times \cdots \times Y^{j_{\ell-1}} \times \cdots \times \Delta^{j_k}) \subset \mathbb{R}^{n+1} \times \{\ell\} \right],$$

and project this into \mathbb{R}^{n+1} . The factor ℓ is in the $(n+2)$ nd coordinate and represents the relative height of each Y .

$$\left[(Y^{j_1-1} \times \Delta^{j_2} \cdots \times \Delta^{j_\ell} \times \cdots \times \Delta^{j_k}) \subset \mathbb{R}^{n+1} \times \{1\} \right],$$

$$\left[\left(Y^{j_1-1} \times \Delta^{j_2} \cdots \times \Delta^{j_\ell} \times \cdots \times \Delta^{j_k} \right) \subset \mathbb{R}^{n+1} \times \{1\} \right],$$

$$\left[\left(\Delta^{j_1} \times Y^{j_2-1} \cdots \times \Delta^{j_\ell} \times \cdots \times \Delta^{j_k} \right) \subset \mathbb{R}^{n+1} \times \{2\} \right],$$

$$[(Y^{j_1-1} \times \Delta^{j_2} \cdots \times \Delta^{j_\ell} \times \cdots \times \Delta^{j_k}) \subset \mathbb{R}^{n+1} \times \{1\}],$$

$$[(\Delta^{j_1} \times Y^{j_2-1} \cdots \times \Delta^{j_\ell} \times \cdots \times \Delta^{j_k}) \subset \mathbb{R}^{n+1} \times \{2\}],$$

...

$$[(Y^{j_1-1} \times \Delta^{j_2} \dots \times \Delta^{j_\ell} \times \dots \times \Delta^{j_k}) \subset \mathbb{R}^{n+1} \times \{1\}],$$

$$[(\Delta^{j_1} \times Y^{j_2-1} \dots \times \Delta^{j_\ell} \times \dots \times \Delta^{j_k}) \subset \mathbb{R}^{n+1} \times \{2\}],$$

...

$$[(\Delta^{j_1} \times \Delta^{j_2} \dots \times Y^{j_\ell-1} \times \dots \times \Delta^{j_k}) \subset \mathbb{R}^{n+1} \times \{\ell\}],$$

$$[(Y^{j_1-1} \times \Delta^{j_2} \dots \times \Delta^{j_\ell} \times \dots \times \Delta^{j_k}) \subset \mathbb{R}^{n+1} \times \{1\}],$$

$$[(\Delta^{j_1} \times Y^{j_2-1} \dots \times \Delta^{j_\ell} \times \dots \times \Delta^{j_k}) \subset \mathbb{R}^{n+1} \times \{2\}],$$

...

$$[(\Delta^{j_1} \times \Delta^{j_2} \dots \times Y^{j_\ell-1} \times \dots \times \Delta^{j_k}) \subset \mathbb{R}^{n+1} \times \{\ell\}],$$

...

$$[(Y^{j_1-1} \times \Delta^{j_2} \dots \times \Delta^{j_\ell} \times \dots \times \Delta^{j_k}) \subset \mathbb{R}^{n+1} \times \{1\}],$$

$$[(\Delta^{j_1} \times Y^{j_2-1} \dots \times \Delta^{j_\ell} \times \dots \times \Delta^{j_k}) \subset \mathbb{R}^{n+1} \times \{2\}],$$

...

$$[(\Delta^{j_1} \times \Delta^{j_2} \dots \times Y^{j_\ell-1} \times \dots \times \Delta^{j_k}) \subset \mathbb{R}^{n+1} \times \{\ell\}],$$

...

$$[(\Delta^{j_1} \times \Delta^{j_2} \dots \times \Delta^{j_\ell} \times \dots \times Y^{j_k-1}) \subset \mathbb{R}^{n+1} \times \{k\}].$$

$$[(Y^{j_1-1} \times \Delta^{j_2} \dots \times \Delta^{j_\ell} \times \dots \times \Delta^{j_k}) \subset \mathbb{R}^{n+1} \times \{1\}],$$

$$[(\Delta^{j_1} \times Y^{j_2-1} \dots \times \Delta^{j_\ell} \times \dots \times \Delta^{j_k}) \subset \mathbb{R}^{n+1} \times \{2\}],$$

...

$$[(\Delta^{j_1} \times \Delta^{j_2} \dots \times Y^{j_\ell-1} \times \dots \times \Delta^{j_k}) \subset \mathbb{R}^{n+1} \times \{\ell\}],$$

...

$$[(\Delta^{j_1} \times \Delta^{j_2} \dots \times \Delta^{j_\ell} \times \dots \times Y^{j_k-1}) \subset \mathbb{R}^{n+1} \times \{k\}].$$

These project to a 0-dimensional multiple point in \mathbb{R}^{n+1} .

The local crossings for $(n + 1)$ -foams are found among the Reidemeister/Roseman moves of the embedded n -foams.

The local crossings for $(n + 1)$ -foams are found among the Reidemeister/Roseman moves of the embedded n -foams. These crossings are the most homologically interesting aspect of group/quandle homology, as they represent generating chains in the chain groups.

Section 3

in which a discussion of categorification is used to justify the ideas presented in the previous slide.

New school categorification

New School: Knots \longrightarrow Alexander, Jones,
HOMFLYPT

New school categorification

New School: Knots \longrightarrow Alexander, Jones,
HOMFLYPT — FLYTHOMP polynomials.

New school categorification

New School: Knots \longrightarrow Alexander, Jones,
HOMFLYPT — FLYTHOMP polynomials.

KhoHo (or HF): Construct a homology theory
whose graded Euler characteristic gives the knot
polynomial.

New school categorification

New School: Knots \longrightarrow Alexander, Jones,
HOMFLYPT — FLYTHOMP polynomials.

KhoHo (or HF): Construct a homology theory
whose graded Euler characteristic gives the knot
polynomial.

Great invariants for classical knots and knot
cobordisms.

New school categorification

New School: Knots \longrightarrow Alexander, Jones,
HOMFLYPT — FLYTHOMP polynomials.

KhoHo (or HF): Construct a homology theory
whose graded Euler characteristic gives the knot
polynomial.

Great invariants for classical knots and knot
cobordisms. Not so good for knotted closed
surfaces.

Old school categorification

Different things can't be equal.

Old school categorification

Different things can't be equal.
Instead they are often related by a natural
isomorphism.

Old school categorification

Different things can't be equal.

Instead they are often related by a natural isomorphism.

Use such isom. to study equality

Old school categorification

Different things can't be equal.

Instead they are often related by a natural isomorphism.

Use such isom. to study equality

Old school categorification

Different things can't be equal.

Instead they are often related by a natural isomorphism.

Use such isom. to study ~~equality~~ relations b/2 objects.

Old school categorification

Different things can't be equal.

Instead they are often related by a natural isomorphism.

Use such isom. to study ~~equality~~ relations b/w objects.

e.g. congruence of geometric figures \mapsto

Old school categorification

Different things can't be equal.

Instead they are often related by a natural isomorphism.

Use such isom. to study ~~equality~~ relations b/w objects.

e.g. congruence of geometric figures \mapsto group of operators on a homogeneous space \mapsto

Old school categorification

Different things can't be equal.

Instead they are often related by a natural isomorphism.

Use such isom. to study ~~equality~~ relations b/w objects.

e.g. congruence of geometric figures \mapsto group of operators on a homogeneous space \mapsto invariants of groups such as homology.

Old school categorification

Different things can't be equal.

Instead they are often related by a natural isomorphism.

Use such isom. to study ~~equality~~ relations b/w objects.

e.g. congruence of geometric figures \mapsto group of operators on a homogeneous space \mapsto invariants of groups such as homology.

Instead of equality among morphisms, posit 2-morphisms that satisfy their own set of relations.

Old school categorification

Different things can't be equal.

Instead they are often related by a natural isomorphism.

Use such isom. to study ~~equality~~ relations b/w objects.

e.g. congruence of geometric figures \mapsto group of operators on a homogeneous space \mapsto invariants of groups such as homology.

Instead of equality among morphisms, posit 2-morphisms that satisfy their own set of relations. Climb the dimension ladder.

Abstract
Tensor
Formalism

Suppose V, W , etc. f.dim'l vec. sp. over \mathbb{F} .

Abstract
Tensor
Formalism

Suppose V, W , etc. f.dim'l vec. sp. over \mathbb{F} .

$$\vec{x} = \sum_{j=1}^n x^j e_j$$

Abstract
Tensor
Formalism

Suppose V, W , etc. f.dim'l vec. sp. over \mathbb{F} .

$$\vec{x} = \sum_{j=1}^n x^j e_j \quad \text{where} \quad e_j = \begin{bmatrix} 0 \\ \vdots \\ 0 \\ 1 \\ 0 \\ \vdots \\ 0 \end{bmatrix} \leftarrow \text{jth} \left. \vphantom{\begin{bmatrix} 0 \\ \vdots \\ 0 \\ 1 \\ 0 \\ \vdots \\ 0 \end{bmatrix}} \right\} \text{n rows}$$

Abstract
Tensor
Formalism

so superscripts are row indices.

Suppose V, W , etc. n -dim'l vec. sp. over \mathbb{F} .

$$\vec{x} = \sum_{j=1}^n x^j e_j \quad \text{where} \quad e_j = \begin{bmatrix} 0 \\ \vdots \\ 0 \\ 1 \\ 0 \\ \vdots \\ 0 \end{bmatrix} \leftarrow \begin{matrix} j\text{th} \\ \left. \vphantom{\begin{matrix} 0 \\ \vdots \\ 0 \\ 1 \\ 0 \\ \vdots \\ 0 \end{matrix}} \right\} n \text{ rows} \end{matrix}$$

Abstract
Tensor
Formalism

so superscripts are row indices.

Write $\vec{x} = \begin{matrix} | \\ \boxed{x} \end{matrix}$.

Suppose V, W , etc. $f.\dim'l$ vec. sp. over F .

$$\vec{x} = \sum_{j=1}^n x^j e_j \quad \text{where} \quad e_j = \begin{bmatrix} 0 \\ \vdots \\ 0 \\ 1 \\ 0 \\ \vdots \\ 0 \end{bmatrix} \leftarrow j\text{th} \left. \vphantom{\begin{bmatrix} 0 \\ \vdots \\ 0 \\ 1 \\ 0 \\ \vdots \\ 0 \end{bmatrix}} \right\} n \text{ rows}$$

Abstract
Tensor
Formalism

so superscripts are row indices.

Write $\vec{x} = \begin{array}{c} | \\ \boxed{x} \\ | \end{array}$. If $W \xleftarrow{A} V$ is linear, $A(e_j) = \sum_{i=1}^n a_j^i e_i$

Write $A = \begin{array}{c} | \\ \boxed{A} \\ | \end{array}$.

Suppose V, W , etc. $f.\dim'l$ vec. sp. over F .

$$\vec{x} = \sum_{j=1}^n x^j e_j \quad \text{where} \quad e_j = \begin{bmatrix} 0 \\ \vdots \\ 0 \\ 1 \\ 0 \\ \vdots \\ 0 \end{bmatrix} \leftarrow \text{jth} \left. \vphantom{\begin{bmatrix} 0 \\ \vdots \\ 0 \\ 1 \\ 0 \\ \vdots \\ 0 \end{bmatrix}} \right\} n \text{ rows}$$

Abstract
Tensor
Formalism

so superscripts are row indices.

Write $\vec{x} = \begin{array}{c} | \\ \boxed{x} \end{array}$. If $W \xleftarrow{A} V$ is linear, $A(e_j) = \sum_{i=1}^n a_j^i e_i$

Write $A = \begin{array}{c} | \\ \boxed{A} \end{array}$. So $Ax=b$ is written $\begin{array}{c} | \\ \boxed{A} \\ | \\ \boxed{x} \end{array} = \begin{array}{c} | \\ \boxed{b} \end{array}$.

Suppose V, W , etc. f.dim'l vec. sp. over F .

$$\vec{x} = \sum_{j=1}^n x^j e_j \quad \text{where} \quad e_j = \begin{bmatrix} 0 \\ \vdots \\ 0 \\ 1 \\ 0 \\ \vdots \\ 0 \end{bmatrix} \leftarrow j\text{th} \left. \vphantom{\begin{bmatrix} 0 \\ \vdots \\ 0 \\ 1 \\ 0 \\ \vdots \\ 0 \end{bmatrix}} \right\} n \text{ rows}$$

Abstract
Tensor
Formalism

so superscripts are row indices.

Write $\vec{x} = \begin{array}{|c} \boxed{x} \end{array}$. If $W \xleftarrow{A} V$ is linear, $A(e_j) = \sum_{i=1}^n a_j^i e_i$

Write $A = \begin{array}{|c} \boxed{A} \end{array}$. So $Ax=b$ is written $\begin{array}{|c} \boxed{A} \\ \boxed{x} \end{array} = \begin{array}{|c} \boxed{b} \end{array}$.

Composition of linear maps is denoted by vertical juxtaposition.

$$T \xleftarrow{C} U \xleftarrow{B} W \xleftarrow{A} V \quad \begin{array}{|c} \boxed{C} \\ \boxed{B} \\ \boxed{A} \end{array} \begin{array}{l} \uparrow \\ T \\ V \end{array}$$

Suppose V, W , etc. f.dim'l vec. sp. over F .

$$\vec{x} = \sum_{j=1}^n x^j e_j \quad \text{where} \quad e_j = \begin{bmatrix} 0 \\ \vdots \\ 0 \\ 1 \\ 0 \\ \vdots \\ 0 \end{bmatrix} \leftarrow j\text{th} \left. \vphantom{\begin{bmatrix} 0 \\ \vdots \\ 0 \\ 1 \\ 0 \\ \vdots \\ 0 \end{bmatrix}} \right\} n \text{ rows}$$

Abstract
Tensor
Formalism

so superscripts are row indices.

Write $\vec{x} = \begin{array}{|c} \boxed{x} \end{array}$. If $W \xleftarrow{A} V$ is linear, $A(e_j) = \sum_{i=1}^n a_j^i e_i$

Write $A = \begin{array}{|c} \boxed{A} \end{array}$. So $Ax=b$ is written $\begin{array}{|c} \boxed{A} \\ \boxed{x} \end{array} = \begin{array}{|c} \boxed{b} \end{array}$.

Composition of linear maps is denoted by vertical juxtaposition.

$$\begin{array}{c} T \xleftarrow{C} U \xleftarrow{B} W \xleftarrow{A} V \\ C(B(A(\vec{x}))) \end{array} \quad \begin{array}{|c} \boxed{C} \\ \boxed{B} \\ \boxed{A} \end{array} \begin{array}{l} \uparrow \\ T \\ V \end{array}$$

Suppose V, W , etc. $f.\dim'l$ vec. sp. over \mathbb{F} .

$$\vec{x} = \sum_{j=1}^n x^j e_j \quad \text{where} \quad e_j = \begin{bmatrix} 0 \\ \vdots \\ 0 \\ 1 \\ 0 \\ \vdots \\ 0 \end{bmatrix} \leftarrow \text{jth} \left. \vphantom{\begin{bmatrix} 0 \\ \vdots \\ 0 \\ 1 \\ 0 \\ \vdots \\ 0 \end{bmatrix}} \right\} n \text{ rows}$$

Abstract
Tensor
Formalism

so superscripts are row indices.

Write $\vec{x} = \begin{array}{|c} \hline x \\ \hline \end{array}$. If $W \xleftarrow{A} V$ is linear, $A(e_j) = \sum_{i=1}^n a_j^i e_i$

Write $A = \begin{array}{|c} \hline A \\ \hline \end{array}$. So $Ax=b$ is written $\begin{array}{|c} \hline A \\ \hline x \end{array} = \begin{array}{|c} \hline b \\ \hline \end{array}$.

Composition of linear maps is denoted by vertical juxtaposition.

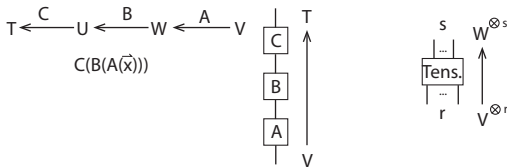

Example: A Frobenius alg. is a v. sp. V tog. w/ linear maps

Example: A Frobenius alg. is a v. sp. V tog. w/ linear maps

$$\begin{array}{c} V \\ \uparrow \\ \text{IF} \end{array} \text{ unit,}$$

Example: A Frobenius alg. is a v. sp. V tog. w/ linear maps

$$\begin{array}{c} V \\ \circ \uparrow \\ \text{IF} \end{array} \text{ unit,} \quad \begin{array}{c} V \\ \wedge \uparrow \\ V \otimes V \end{array} \text{ multi.,}$$

Example: A Frobenius alg. is a v. sp. V tog. w/ linear maps



Example: A Frobenius alg. is a v. sp. V tog. w/ linear maps

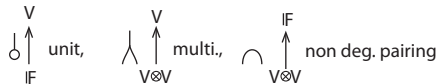

that satisfy:

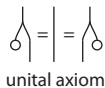

Example: A Frobenius alg. is a v. sp. V tog. w/ linear maps

$$\begin{array}{c} V \\ \uparrow \\ \circ \quad | \\ \text{IF} \end{array} \text{ unit,} \quad \begin{array}{c} V \\ \uparrow \\ \wedge \\ V \otimes V \end{array} \text{ multi.,} \quad \begin{array}{c} \text{IF} \\ \uparrow \\ \cup \\ V \otimes V \end{array} \text{ non deg. pairing}$$

that satisfy:

$$\begin{array}{c} \circ \quad | \\ \wedge \\ \text{unit axiom} \end{array} = \begin{array}{c} | \\ \wedge \\ \circ \end{array} \quad \text{here } \begin{array}{c} | \\ \text{denotes the identity map} \\ | \\ V \end{array}$$

Example: A Frobenius alg. is a v. sp. V tog. w/ linear maps

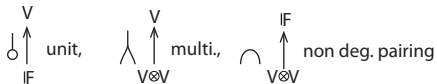

that satisfy:



unital axiom



associativity

Example: A Frobenius alg. is a v. sp. V tog. w/ linear maps

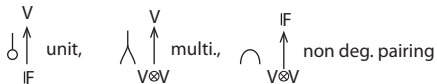

that satisfy:



unital axiom



associativity associativity of the pairing

Example: A Frobenius alg. is a v. sp. V tog. w/ linear maps

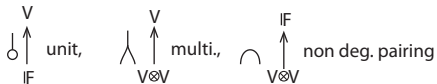

that satisfy:

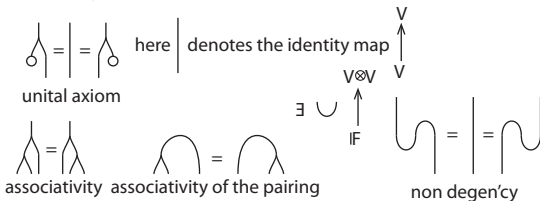

Example: A Frobenius alg. is a v. sp. V tog. w/ linear maps

$$\begin{array}{c} V \\ \uparrow \\ \circlearrowleft \\ \text{IF} \end{array} \text{ unit,} \quad \begin{array}{c} V \\ \uparrow \\ \wedge \\ V \otimes V \end{array} \text{ multi.,} \quad \begin{array}{c} \text{IF} \\ \uparrow \\ \cup \\ V \otimes V \end{array} \text{ non deg. pairing}$$

that satisfy:

$$\begin{array}{c} \circlearrowleft = | = \circlearrowright \\ \text{unital axiom} \end{array} \quad \text{here } | \text{ denotes the identity map} \quad \begin{array}{c} V \\ \uparrow \\ V \\ \text{IF} \end{array}$$

$$\begin{array}{c} \wedge = \wedge \\ \text{associativity} \end{array} \quad \begin{array}{c} \cup = \cup \\ \text{associativity of the pairing} \end{array} \quad \exists \begin{array}{c} \cup \\ \uparrow \\ \text{IF} \end{array} \quad \begin{array}{c} \cup = | = \cup \\ \text{non degen'cy} \end{array}$$

We can use \cup and \cap to define comulti.

Example: A Frobenius alg. is a v. sp. V tog. w/ linear maps

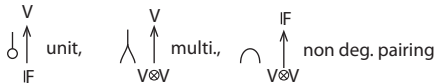

that satisfy:

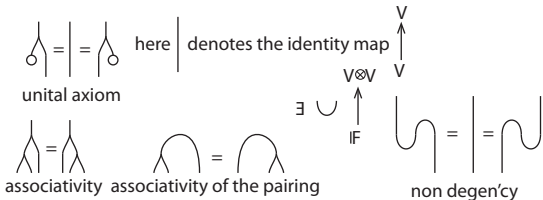

We can use \cup and \cap to define comulti.

$$\Upsilon := \cup = \cap$$

Example: A Frobenius alg. is a v. sp. V tog. w/ linear maps

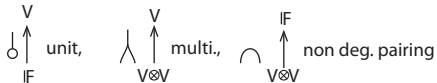

that satisfy:

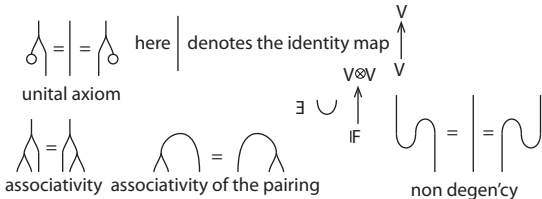

We can use \cup and \cap to define comulti. and counit.



Example: A Frobenius alg. is a v. sp. V tog. w/ linear maps

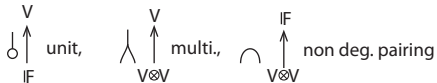

that satisfy:

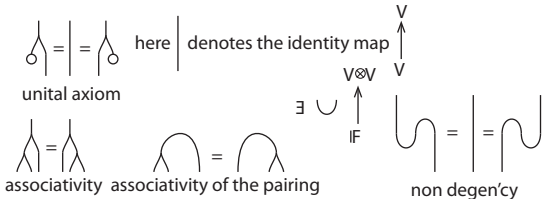

We can use \cup and \cap to define comulti. and counit.



It's remarkable that most of the axiomatics for the alg.coalg str. follows directly from the diagrammatics.

So a Frobenius algebra has a categorical analogue. Just assert the existence of a monoidal category together with maps Y , *etc.*

So a Frobenius algebra has a categorical analogue. Just assert the existence of a monoidal category together with maps Y , *etc.* So let's look at slightly weaker monoidal category.

So a Frobenius algebra has a categorical analogue. Just assert the existence of a monoidal category together with maps Y , *etc.* So let's look at slightly weaker monoidal category.

- Objects $\leftrightarrow \mathbb{N} = \{0, 1, \dots\}$ written in unary notation.

So a Frobenius algebra has a categorical analogue. Just assert the existence of a monoidal category together with maps Y , *etc.* So let's look at slightly weaker monoidal category.

- Objects $\leftrightarrow \mathbb{N} = \{0, 1, \dots\}$ written in unary notation.
- morphisms gen. by $X, Y, \wedge, \vee, \bar{X}, \cup, \cap$

So a Frobenius algebra has a categorical analogue. Just assert the existence of a monoidal category together with maps Y , *etc.* So let's look at slightly weaker monoidal category.

- Objects $\leftrightarrow \mathbb{N} = \{0, 1, \dots\}$ written in unary notation.
- morphisms gen. by $X, Y, \wedge, \vee, \bar{X}, \cup, \cap$ — here, of course, 1 denotes the identity morphism.

So a Frobenius algebra has a categorical analogue. Just assert the existence of a monoidal category together with maps Y , *etc.* So let's look at slightly weaker monoidal category.

- Objects $\leftrightarrow \mathbb{N} = \{0, 1, \dots\}$ written in unary notation.
- morphisms gen. by $X, Y, \wedge, \vee, \bar{X}, \cup, \cap$ — here, of course, 1 denotes the identity morphism.
- \otimes on objects is addition.

So a Frobenius algebra has a categorical analogue. Just assert the existence of a monoidal category together with maps Y , *etc.* So let's look at slightly weaker monoidal category.

- Objects $\leftrightarrow \mathbb{N} = \{0, 1, \dots\}$ written in unary notation.
- morphisms gen. by $X, Y, \wedge, I, \bar{X}, \cup, \cap$ — here, of course, I denotes the identity morphism.
- \otimes on objects is addition.
- \otimes on morphisms is (sort of) determined by horizontal juxt.

So a Frobenius algebra has a categorical analogue. Just assert the existence of a monoidal category together with maps Y , *etc.* So let's look at slightly weaker monoidal category.

- Objects $\leftrightarrow \mathbb{N} = \{0, 1, \dots\}$ written in unary notation.
- morphisms gen. by $X, Y, \wedge, \vee, \bar{X}, \cup, \cap$ — here, of course, 1 denotes the identity morphism.
- \otimes on objects is addition.
- \otimes on morphisms is (sort of) determined by horizontal juxt.

but WAIT!

So a Frobenius algebra has a categorical analogue. Just assert the existence of a monoidal category together with maps Y , *etc.* So let's look at slightly weaker monoidal category.

- Objects $\leftrightarrow \mathbb{N} = \{0, 1, \dots\}$ written in unary notation.
- morphisms gen. by $X, Y, \wedge, \vee, \bar{X}, \cup, \cap$ — here, of course, 1 denotes the identity morphism.
- \otimes on objects is addition.
- \otimes on morphisms is (sort of) determined by horizontal juxt.

but WAIT!

So a Frobenius algebra has a categorical analogue. Just assert the existence of a monoidal category together with maps Y , *etc.* So let's look at slightly weaker monoidal category.

- Objects $\leftrightarrow \mathbb{N} = \{0, 1, \dots\}$ written in unary notation.
- morphisms gen. by $X, Y, \wedge, \vee, \bar{X}, \cup, \cap$ — here, of course, 1 denotes the identity morphism.
- \otimes on objects is addition.
- \otimes on morphisms is (sort of) determined by horizontal juxt.

but WAIT! Don't assert identities among the 1-morphisms.

Don't assert identities among
1-morphism!

Instead, assert the existence of 2-morphisms.

Don't assert identities among 1-morphism!

Instead, assert the existence of 2-morphisms.
These can point in either direction.

Don't assert identities among 1-morphism!

Instead, assert the existence of 2-morphisms.
These can point in either direction. Sometimes
the composition is invertible in either direction.

Don't assert identities among 1-morphism!

Instead, assert the existence of 2-morphisms.
These can point in either direction. Sometimes
the composition is invertible in either direction.
Sometimes not.

Don't assert identities among 1-morphism!

Instead, assert the existence of 2-morphisms.
These can point in either direction. Sometimes
the composition is invertible in either direction.
Sometimes not.
; Either direction?

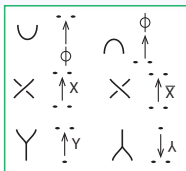

Generating 1-morphs

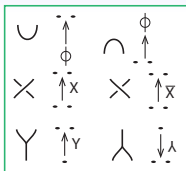

Generating 1-morphs

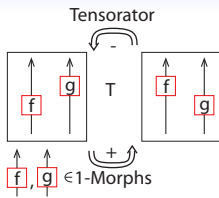

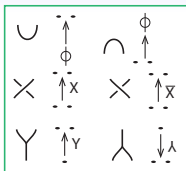

Generating 1-morphs

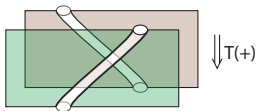
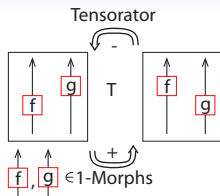

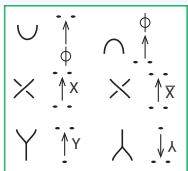

Generating 1-morphs

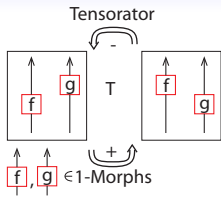

Tensorator

$f, g \in 1\text{-Morphs}$

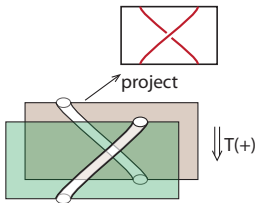

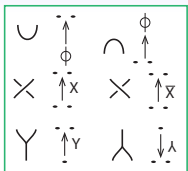

Generating 1-morphs

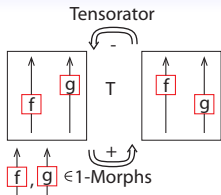

Relations (3-morphism)

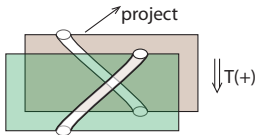

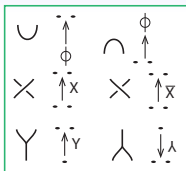

Generating 1-morphs

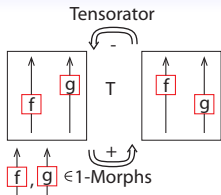

Relations (3-morphism)

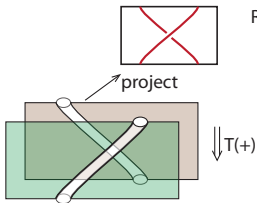
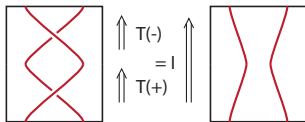

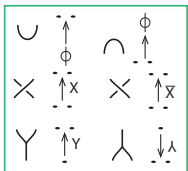

Generating 1-morphs

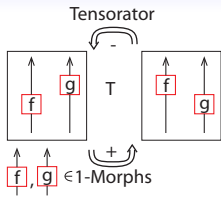
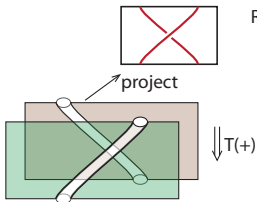

Relations (3-morphism)

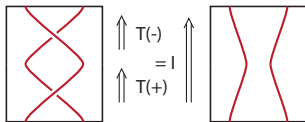

ditto for $T(+)$, $T(-)$

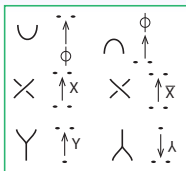

Generating 1-morphs

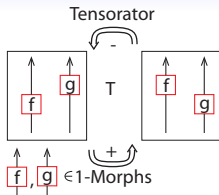

Relations (3-morphism)

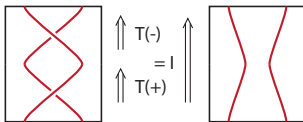

ditto for $T(+)$, $T(-)$

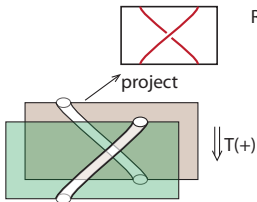

$T(\pm)$ is natural w.r.t.
any 2-morph.

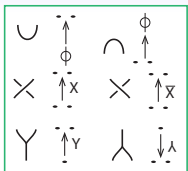

Generating 1-morphisms

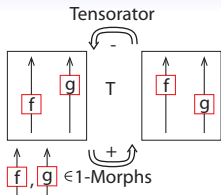

Relations (3-morphism)

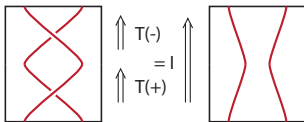

ditto for $T(+)\circ T(-)$

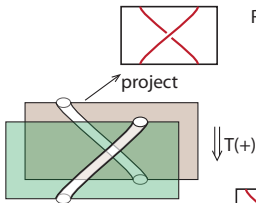
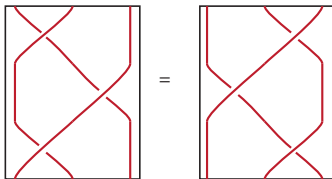

$T(\pm)$ is natural w.r.t. any 2-morph.

In part.:

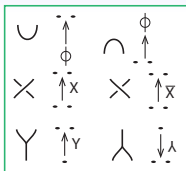

Generating 1-morphs

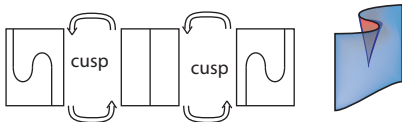
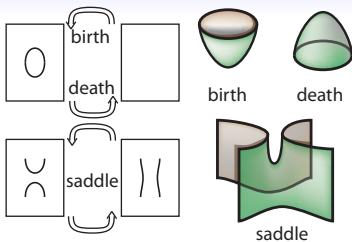

- The critical points evolve to be come folds.
(co-oriented away from optimal points)
- Several obvious relations hold among these 2-morphisms.
Including
 - canceling birth/saddle death/saddle
 - lips
 - beak-to-beak
 - swallow-tail
 - horizontal cusp

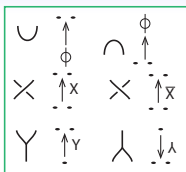

Generating 1-morphs

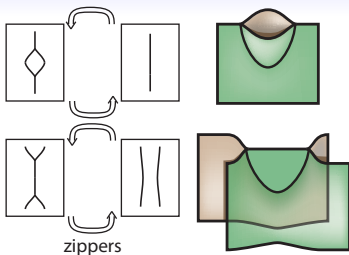

- The vertices of Y or λ evolve to form seams of the foam.
(co-oriented towards the single sheet)
- There are zig-zag moves that cancel a pair of zipper 2-morphisms.
- Under some circumstances, one might want to suppose bubble and saddle moves hold.
But, as is the case with birth followed by death,
or a pair of opposite saddles,
it is better to suppose that the moves
in the next slide are some type of 3-morphisms.

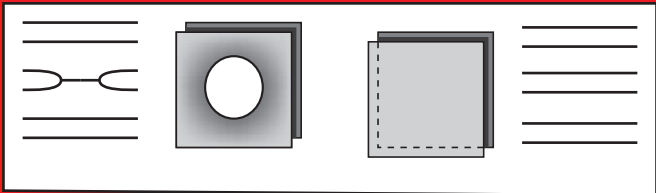
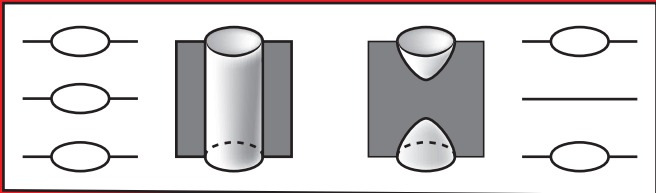
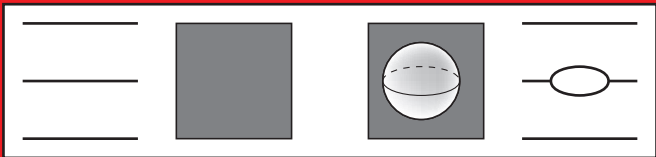

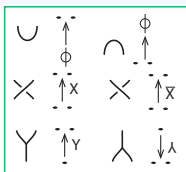

Generating 1-morphs

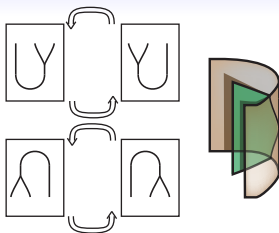

speedometers

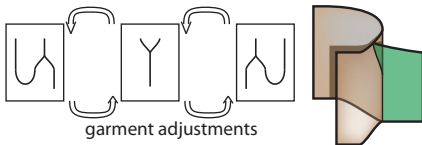

garment adjustments

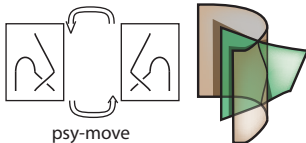

psy-move

- These 2-morphs indicate how folds, seams, double points can interact.
- Each move is invertible in both directions.

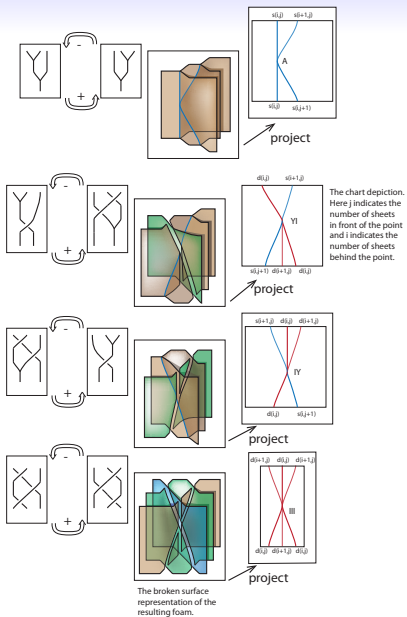

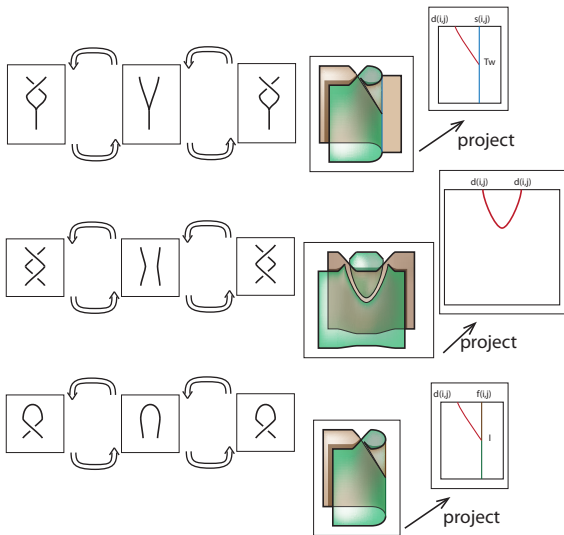

Section 4

in which an homology theory that encompasses both quandle and group homology is outlined.

Fundamental group

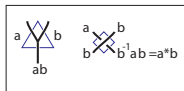

$$(ab)c = a(bc)$$

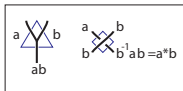
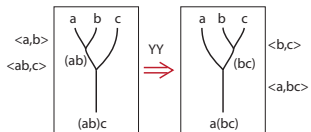

$$(ab)c = a(bc)$$

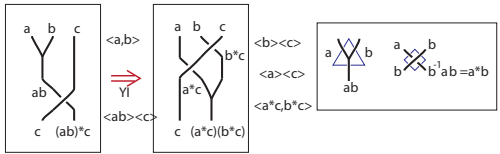
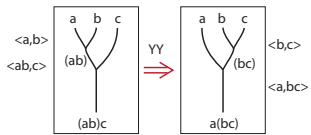

$$(ab)^*c = (a^*c)(b^*c)$$

$$(ab)c = a(bc)$$

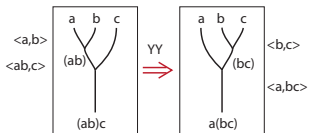

$$(a^*b)^*c = a^*(bc)$$

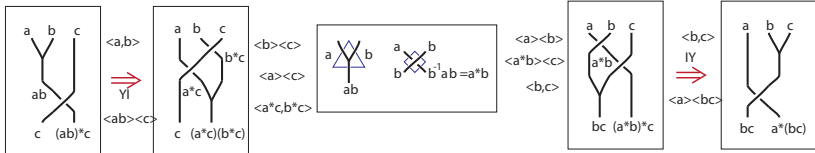

$$(ab)^*c = (a^*c)(b^*c)$$

$$(ab)c = a(bc)$$

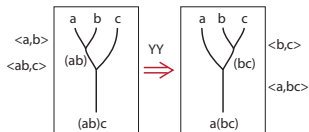

$$(a^*b)^*c = a^*(bc)$$

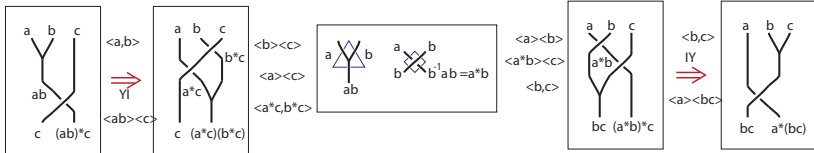

$$(ab)^*c = (a^*c)(b^*c)$$

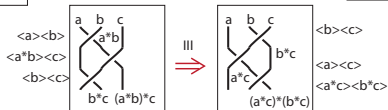

$$(a^*b)^*c = (a^*c)^*(b^*c)$$

$$\text{YY} \quad (ab)c = a(bc),$$

$$\text{IY} : \quad (ab) \triangleleft c = (a \triangleleft c)(b \triangleleft c),$$

$$\text{YI} : \quad (a \triangleleft b) \triangleleft c = a \triangleleft (bc),$$

$$\text{III} : \quad (a \triangleleft b) \triangleleft c = (a \triangleleft c) \triangleleft (b \triangleleft c).$$

A quandle

satisfies three axioms that correspond to the Reidemeister moves:

$$I : \quad (\forall a) : \quad a \triangleleft a = a$$

$$II : \quad (\forall a, b)(\exists c) : \quad c \triangleleft b = a$$

$$III : \quad (\forall a, b, c) : \quad (a \triangleleft b) \triangleleft c = (a \triangleleft c) \triangleleft (b \triangleleft c).$$

A quandle

satisfies three axioms that correspond to the Reidemeister moves:

$$I : \quad (\forall a) : \quad a \triangleleft a = a$$

$$II : \quad (\forall a, b)(\exists c) : \quad c \triangleleft b = a$$

$$III : \quad (\forall a, b, c) : \quad (a \triangleleft b) \triangleleft c = (a \triangleleft c) \triangleleft (b \triangleleft c).$$

We are interested in how the group G and its associated quandle $\text{Conj}(G)$ interact.

Remark

There are related concepts for which the homology sketched below applies, *e.g.*:

Remark

There are related concepts for which the homology sketched below applies, *e.g.*:

- G -families of quandles (IIJO)

Remark

There are related concepts for which the homology sketched below applies, *e.g.*:

- G -families of quandles (IIJO)
- MCQ

Remark

There are related concepts for which the homology sketched below applies, *e.g.*:

- G -families of quandles (IIJO)
- MCQ multiple conjugation quandles (Ishii,

Remark

There are related concepts for which the homology sketched below applies, *e.g.*:

- G -families of quandles (IIJO)
- MCQ multiple conjugation quandles (Ishii, See also CIST)

Remark

There are related concepts for which the homology sketched below applies, *e.g.*:

- G -families of quandles (IIJO)
- MCQ multiple conjugation quandles (Ishii, See also CIST)
- Lebed's qualgebras

Homology of G -families of quandles was defined to study handle-body knots.

Homology of G -families of quandles was defined to study handle-body knots. The higher dim'l versions can be used to study foams.

Homology of G -families of quandles was defined to study handle-body knots. The higher dim'l versions can be used to study foams.

Here we use, YY , YI , IY , and III to define the homological conditions.

Slicing

Cut the interval $[0, n]$ into integral pieces.

Slicing

Cut the interval $[0, n]$ into integral pieces.

$$\langle 1, 2, \dots, \ell_1 \rangle \langle \ell_1 + 1, \dots, \ell_1 + \ell_2 \rangle \cdots \\ \left\langle \sum_{i=1}^{j-1} \ell_i + 1, \dots, \sum_{i=1}^j \ell_i \right\rangle \cdots \left\langle \sum_{i=1}^k \ell_i + 1, \dots, n \right\rangle.$$

Slicing

Cut the interval $[0, n]$ into integral pieces.

$$\langle 1, 2, \dots, \ell_1 \rangle \langle \ell_1 + 1, \dots, \ell_1 + \ell_2 \rangle \cdots \\ \left\langle \sum_{i=1}^{j-1} \ell_i + 1, \dots, \sum_{i=1}^j \ell_i \right\rangle \cdots \left\langle \sum_{i=1}^k \ell_i + 1, \dots, n \right\rangle.$$

Such a slice corresponds to a decomposition of the n -ball into a product of simplices. There are 2^{n-1} ways to cut.

Boundaries

$$\partial\langle j + 1, j + 2, \dots, j + k \rangle$$

Boundaries

$$\begin{aligned} \partial\langle j + 1, j + 2, \dots, j + k \rangle \\ = \triangleleft(j + 1)\langle j + 2, \dots, j + k \rangle \end{aligned}$$

Boundaries

$$\begin{aligned} & \partial \langle j + 1, j + 2, \dots, j + k \rangle \\ &= \triangleleft (j + 1) \langle j + 2, \dots, j + k \rangle \\ &+ \sum_{\ell=1}^{k-1} (-1)^\ell \langle j + 1, \dots, (j + \ell) \cdot (j + \ell + 1), \dots, j + k \rangle \end{aligned}$$

Boundaries

$$\begin{aligned} & \partial \langle j+1, j+2, \dots, j+k \rangle \\ &= \triangleleft (j+1) \langle j+2, \dots, j+k \rangle \\ &+ \sum_{\ell=1}^{k-1} (-1)^\ell \langle j+1, \dots, (j+\ell) \cdot (j+\ell+1), \dots, j+k \rangle \\ &+ (-1)^k \langle j+1, \dots, j+k-1 \rangle. \end{aligned}$$

Boundaries

$$\begin{aligned} & \partial \langle j+1, j+2, \dots, j+k \rangle \\ &= \triangleleft (j+1) \langle j+2, \dots, j+k \rangle \\ &+ \sum_{\ell=1}^{k-1} (-1)^\ell \langle j+1, \dots, (j+\ell) \cdot (j+\ell+1), \dots, j+k \rangle \\ &+ (-1)^k \langle j+1, \dots, j+k-1 \rangle. \end{aligned}$$

$$\partial(PQ) = (\partial P)Q + (-1)^{\dim P} P(\partial Q).$$

Boundaries

$$\begin{aligned} \partial \langle j+1, j+2, \dots, j+k \rangle &= \triangleleft (j+1) \langle j+2, \dots, j+k \rangle \\ &+ \sum_{\ell=1}^{k-1} (-1)^\ell \langle j+1, \dots, (j+\ell) \cdot (j+\ell+1), \dots, j+k \rangle \\ &+ (-1)^k \langle j+1, \dots, j+k-1 \rangle. \end{aligned}$$

$$\partial(PQ) = (\partial P)Q + (-1)^{\dim P} P(\partial Q).$$

In part,

$$\partial \langle j+1 \rangle = \triangleleft (j+1) \lrcorner - \lrcorner.$$

Following Przytycki, one can observe that $\partial \circ \partial = 0$ in this context, if and only if

- $a(bc) = (ab)c$
- $a \triangleleft (bc) = (a \triangleleft b) \triangleleft c$
- $(ab) \triangleleft c = (a \triangleleft c)(b \triangleleft c)$
- $(a \triangleleft b) \triangleleft c = (a \triangleleft c) \triangleleft (b \triangleleft c)$

Sample computations 1

$$\begin{aligned}\partial\langle 1, 2, 3 \rangle &= \langle 2, 3 \rangle - \langle 1 \cdot 2, 3 \rangle \\ &\quad + \langle 1, 2 \cdot 3 \rangle - \langle 1, 2 \rangle\end{aligned}$$

Sample computations 1

$$\partial\langle 1, 2, 3 \rangle = \langle 2, 3 \rangle - \langle 1 \cdot 2, 3 \rangle \\ + \langle 1, 2 \cdot 3 \rangle - \langle 1, 2 \rangle$$

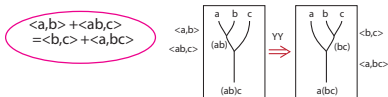

Sample computations 2

$$\begin{aligned}\partial\langle 1, 2 \rangle \langle 3 \rangle &= \partial\langle 1, 2 \rangle \langle 3 \rangle + \langle 1, 2 \rangle \triangleleft (3) - \langle 1, 2 \rangle \\ &= \langle 2 \rangle \langle 3 \rangle - \langle 1 \cdot 2 \rangle \langle 3 \rangle + \langle 1 \rangle \langle 3 \rangle \\ &\quad + \langle 1 \triangleleft 3, 2 \triangleleft 3 \rangle - \langle 1, 2 \rangle\end{aligned}$$

Sample computations 2

$$\begin{aligned}
 \partial\langle 1, 2 \rangle \langle 3 \rangle &= \partial\langle 1, 2 \rangle \langle 3 \rangle + \langle 1, 2 \rangle \triangleleft (3) - \langle 1, 2 \rangle \\
 &= \langle 2 \rangle \langle 3 \rangle - \langle 1 \cdot 2 \rangle \langle 3 \rangle + \langle 1 \rangle \langle 3 \rangle \\
 &\quad + \langle 1 \triangleleft 3, 2 \triangleleft 3 \rangle - \langle 1, 2 \rangle
 \end{aligned}$$

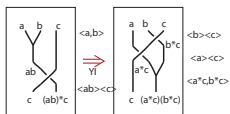

$$\begin{aligned}
 &\langle a,b \rangle + \langle ab \rangle \langle c \rangle \\
 &= \langle b \rangle \langle c \rangle + \langle a \rangle \langle c \rangle \\
 &\quad + \langle a^*c, b^*c \rangle
 \end{aligned}$$

Sample computations 3

$$\begin{aligned}\partial\langle 1 \rangle \langle 2, 3 \rangle &= \langle 2, 3 \rangle - \langle 2, 3 \rangle - \langle 1 \rangle \partial \langle 2, 3 \rangle \\ &= -\langle 1 \triangleleft 2 \rangle \langle 3 \rangle + \langle 1 \rangle \langle 2 \cdot 3 \rangle - \langle 1 \rangle \langle 2 \rangle\end{aligned}$$

Sample computations 3

$$\begin{aligned} \partial\langle 1 \rangle \langle 2, 3 \rangle &= \langle 2, 3 \rangle - \langle 2, 3 \rangle - \langle 1 \rangle \partial \langle 2, 3 \rangle \\ &= -\langle 1 \triangleleft 2 \rangle \langle 3 \rangle + \langle 1 \rangle \langle 2 \cdot 3 \rangle - \langle 1 \rangle \langle 2 \rangle \end{aligned}$$

$$\begin{aligned} \langle a \rangle \langle b \rangle + \langle a * b \rangle \langle c \rangle \\ + \langle b, c \rangle = \langle b, c \rangle + \langle a \rangle \langle bc \rangle \end{aligned}$$

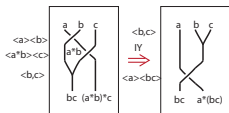

Sample computations

$$\begin{aligned}\partial\langle 1\rangle\langle 2\rangle\langle 3\rangle &= \langle 2\rangle\langle 3\rangle - \langle 2\rangle\langle 3\rangle - \langle 1\rangle\partial(\langle 2\rangle\langle 3\rangle) \\ &= -\langle 1\triangleleft 2\rangle\langle 3\rangle + \langle 1\rangle\langle 3\rangle \\ &\quad +\langle 1\triangleleft 3\rangle\langle 2\triangleleft 3\rangle - \langle 1\rangle\langle 2\rangle\end{aligned}$$

Sample computations

$$\begin{aligned}
 \partial\langle 1 \rangle \langle 2 \rangle \langle 3 \rangle &= \langle 2 \rangle \langle 3 \rangle - \langle 2 \rangle \langle 3 \rangle - \langle 1 \rangle \partial(\langle 2 \rangle \langle 3 \rangle) \\
 &= -\langle 1 \triangleleft 2 \rangle \langle 3 \rangle + \langle 1 \rangle \langle 3 \rangle \\
 &\quad + \langle 1 \triangleleft 3 \rangle \langle 2 \triangleleft 3 \rangle - \langle 1 \rangle \langle 2 \rangle
 \end{aligned}$$

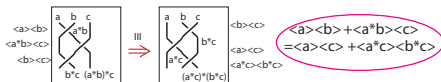

$$\langle a, b \rangle + \langle ab, c \rangle = \langle b, c \rangle + \langle a, bc \rangle$$

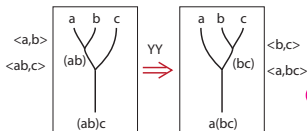

$$\langle a \rangle \langle b \rangle + \langle a^* b \rangle \langle c \rangle + \langle b, c \rangle = \langle b, c \rangle + \langle a \rangle \langle bc \rangle$$

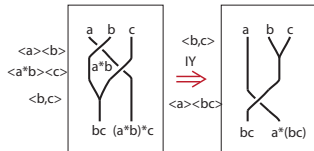
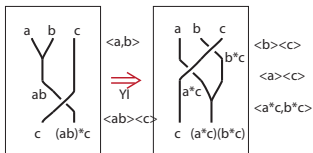

$$\langle a, b \rangle + \langle ab \rangle \langle c \rangle = \langle b \rangle \langle c \rangle + \langle a \rangle \langle c \rangle + \langle a^* c, b^* c \rangle$$

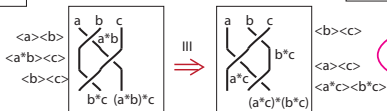

$$\langle a \rangle \langle b \rangle + \langle a^* b \rangle \langle c \rangle = \langle a \rangle \langle c \rangle + \langle a^* c \rangle \langle b^* c \rangle$$

Triangles and Squares

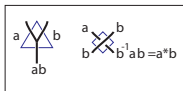

Tetrahedron

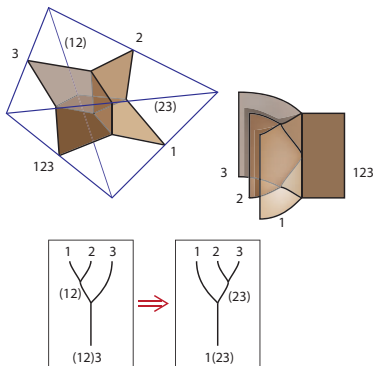

First Prism

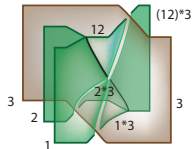
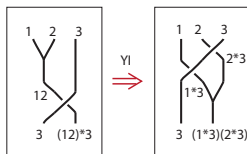
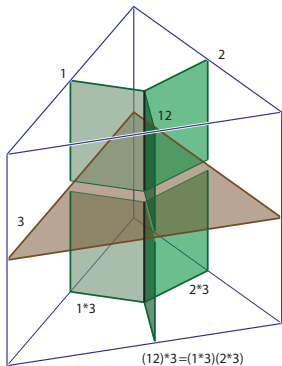

Second Prism

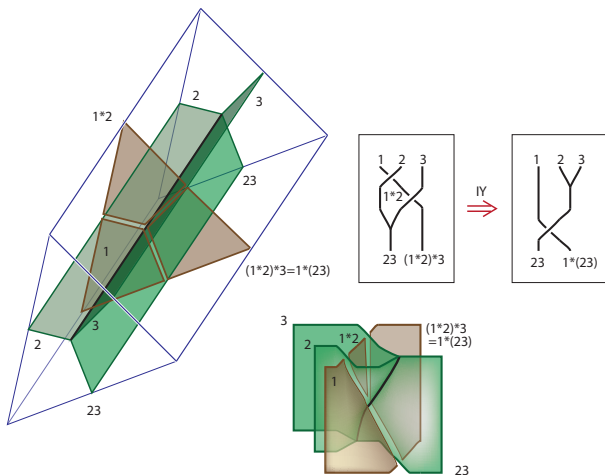

Cube

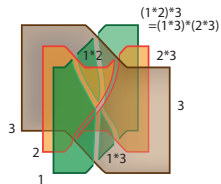
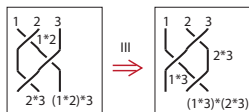
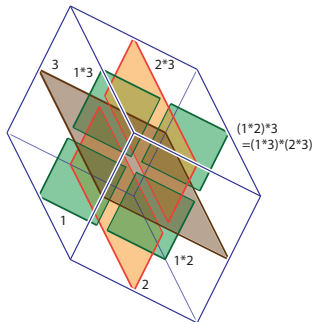

8 interesting moves

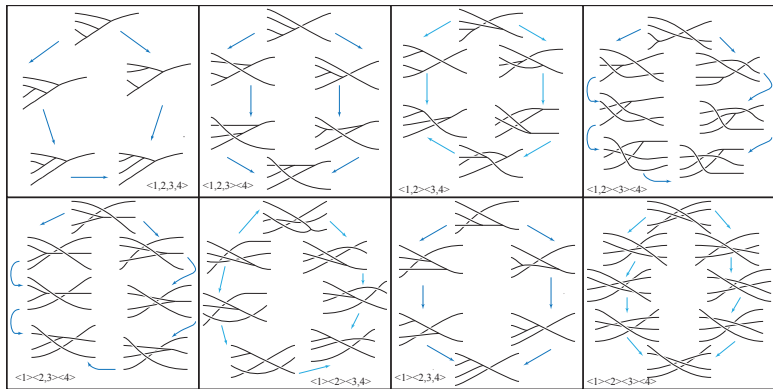

The YYY-move (Stasheff polytope)

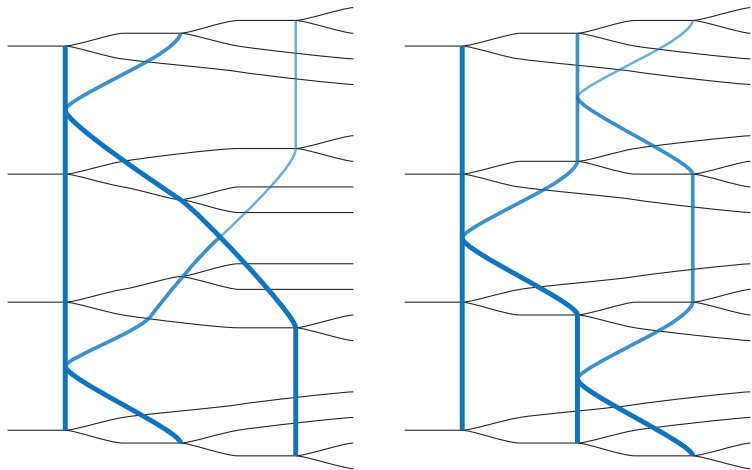

The YII-move

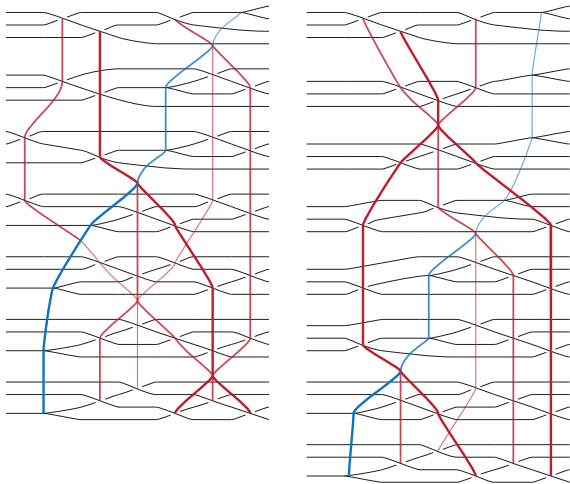

The IY-move

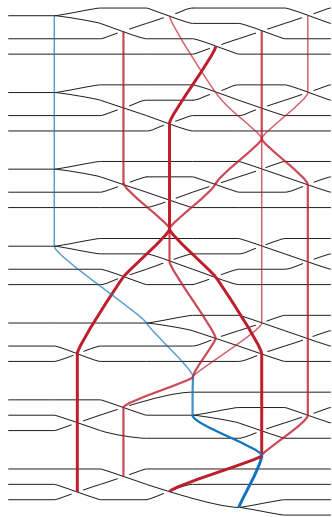

IY

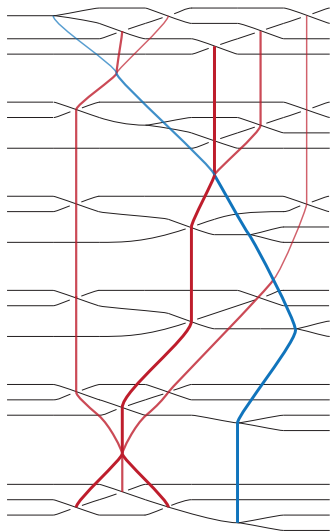

The IYI-move

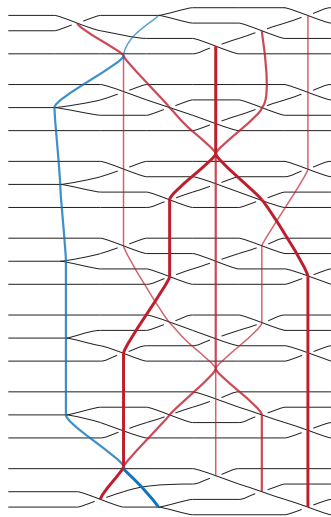
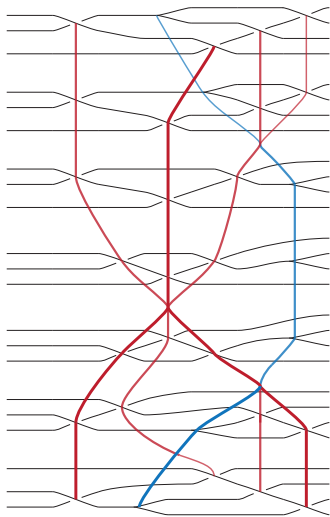

The YY-move

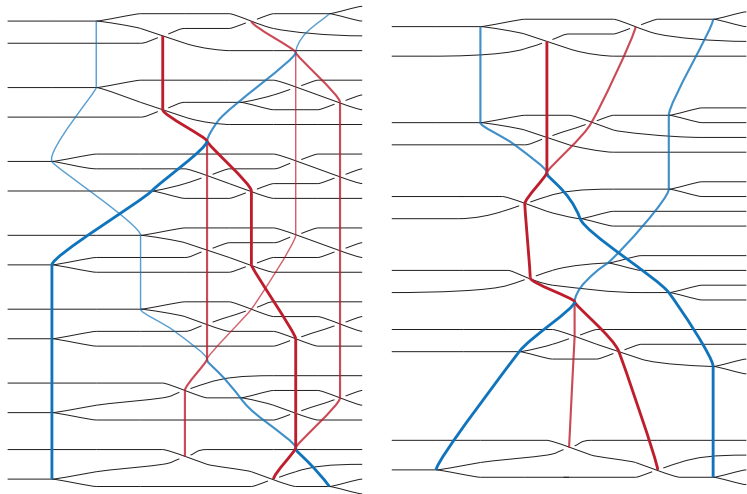

The YYI-move

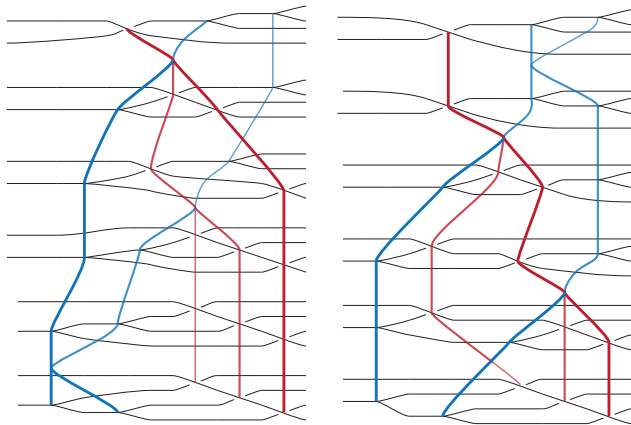

The IYY-move

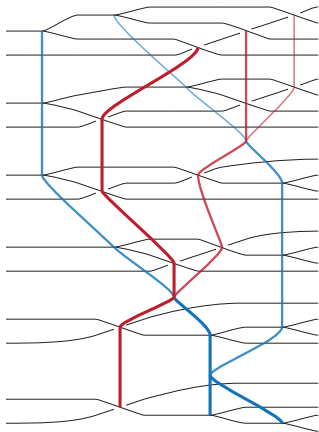
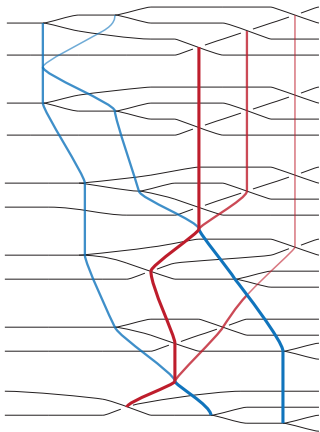

The tetrahedral-move

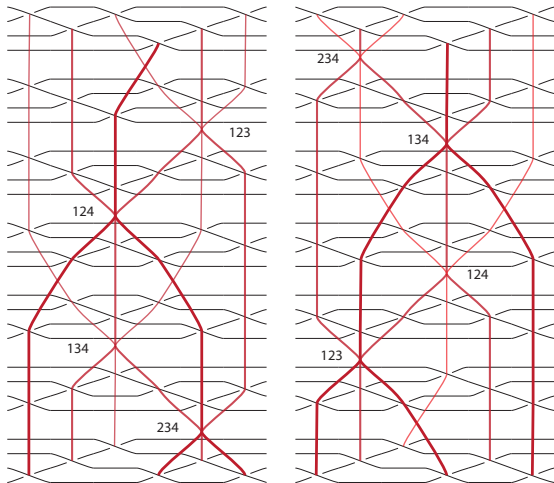

The tetrahedral-move

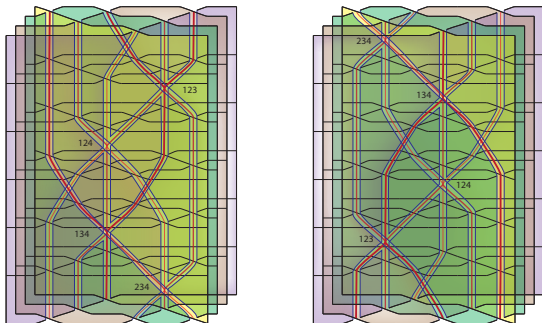

Visual interlude

in which many (not all) of the Reidemeister/Roseman moves for 2-foams are indicated.

Visual interlude

in which many (not all) of the Reidemeister/Roseman moves for 2-foams are indicated. Categorical hint:

Visual interlude

in which many (not all) of the Reidemeister/Roseman moves for 2-foams are indicated. Categorical hint: when certain 2-morphisms are defined to be invertible, these moves arise.

Critical points of the branch point set

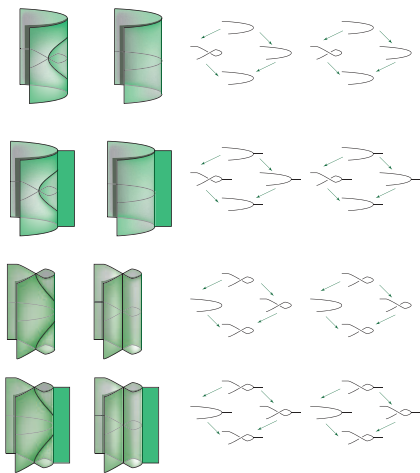

Critical points of the triple point set

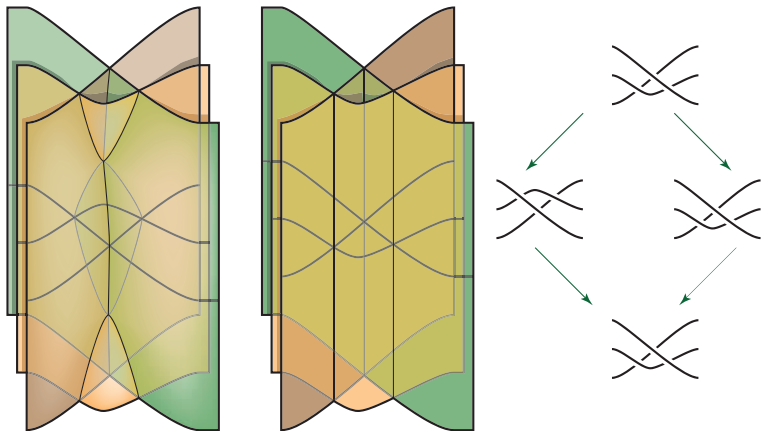

Critical points of the intersection set 1

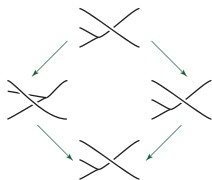
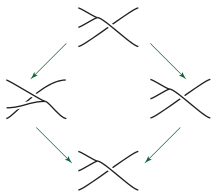
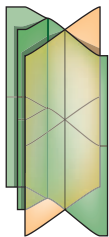
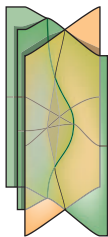

Critical points of the intersection set 2

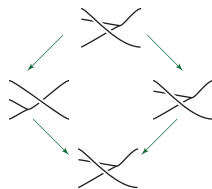
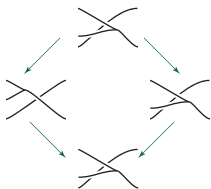
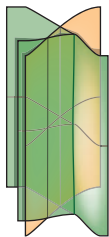
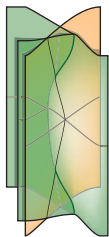

Critical points of the double point set

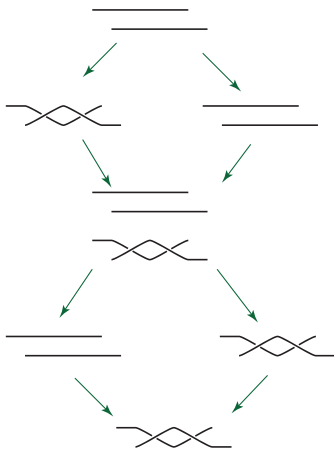
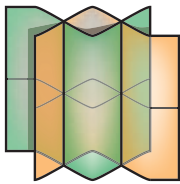
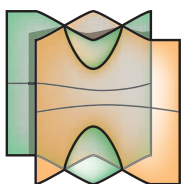
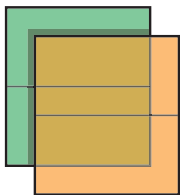
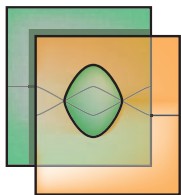

Int. pts. $b/2$ branch/twist set and trnsvs.
sheet

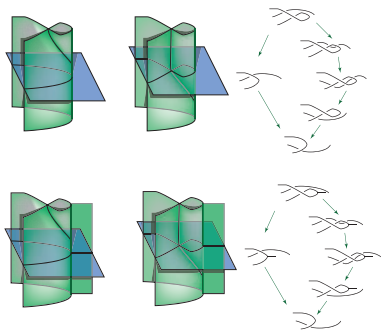

Not all 3-morphisms (or identities among 2 morphisms) are listed here.

Not all 3-morphisms (or identities among 2 morphisms) are listed here. Some missing moves are due to considerations on charts.

Not all 3-morphisms (or identities among 2 morphisms) are listed here. Some missing moves are due to considerations on charts. I just haven't drawn them yet.

Not all 3-morphisms (or identities among 2 morphisms) are listed here. Some missing moves are due to considerations on charts. I just haven't drawn them yet. Others are not listed here for spacial considerations.

The analogues in one higher dimensions

of the generating chains in homology.

The analogues in one higher dimensions

of the generating chains in homology. One bit of the visual interlude is finished,

The analogues in one higher dimensions

of the generating chains in homology. One bit of the visual interlude is finished, but I want to astound you a little more.

1|2|3|4|5

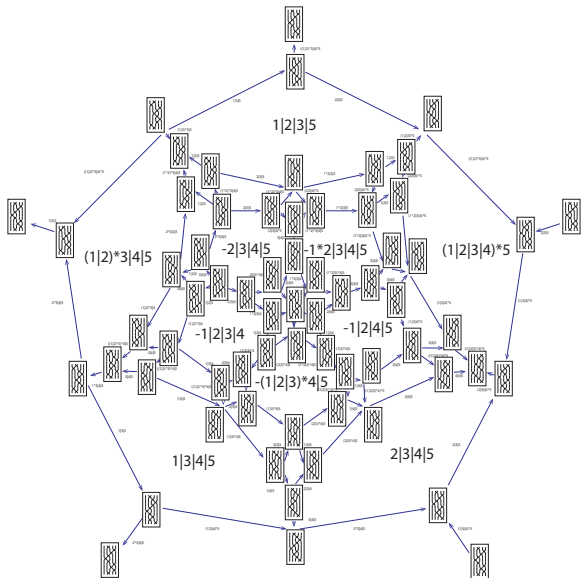

1234|5

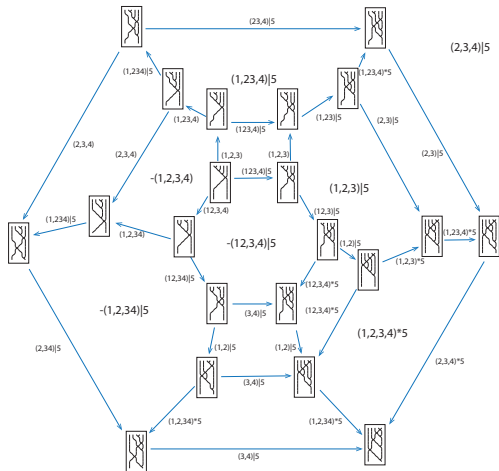

1|2345

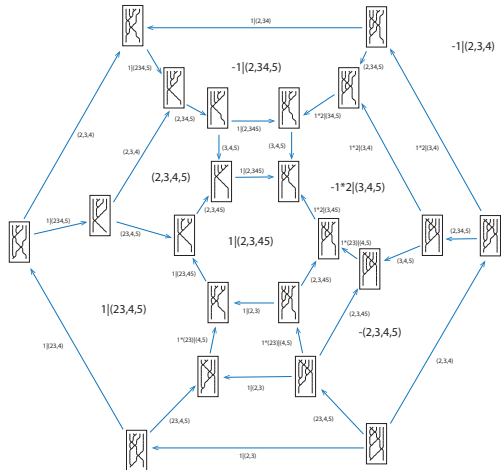

12|345

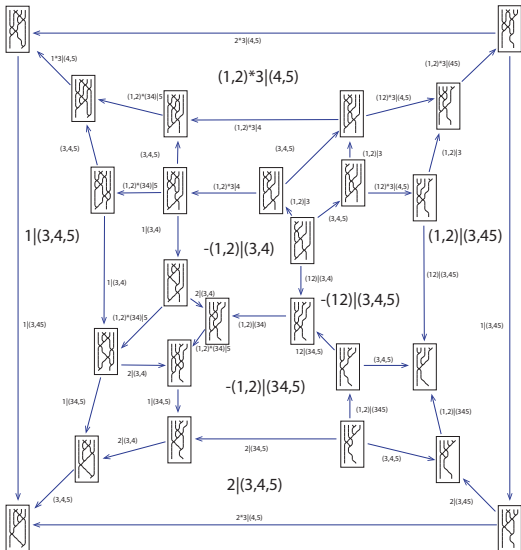

123|45

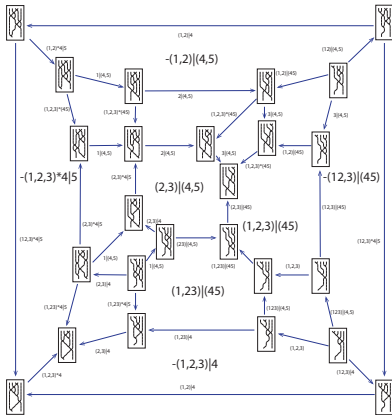

123|4|5

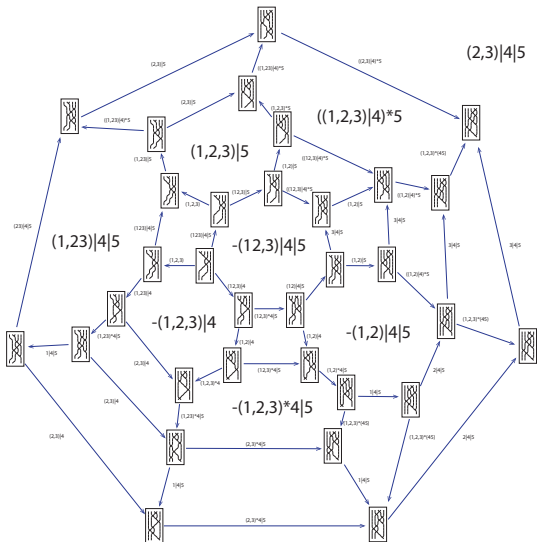

1|2|345

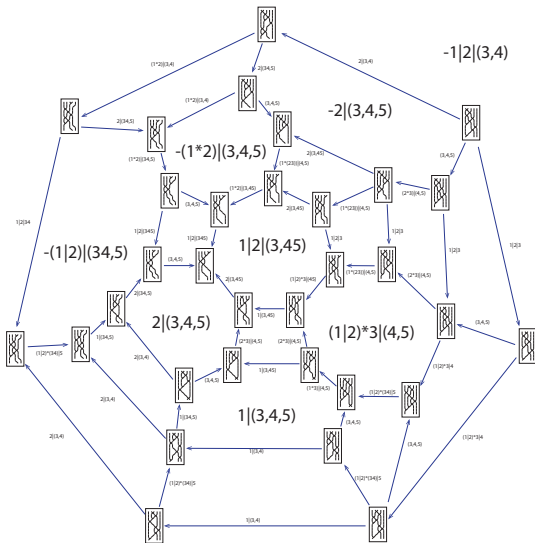

1|234|5

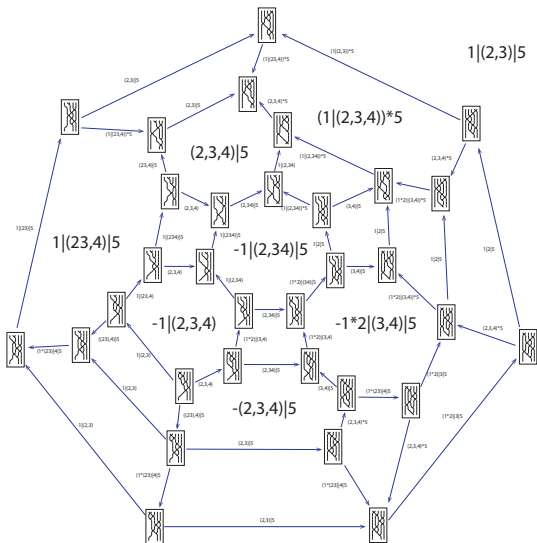

12|34|5

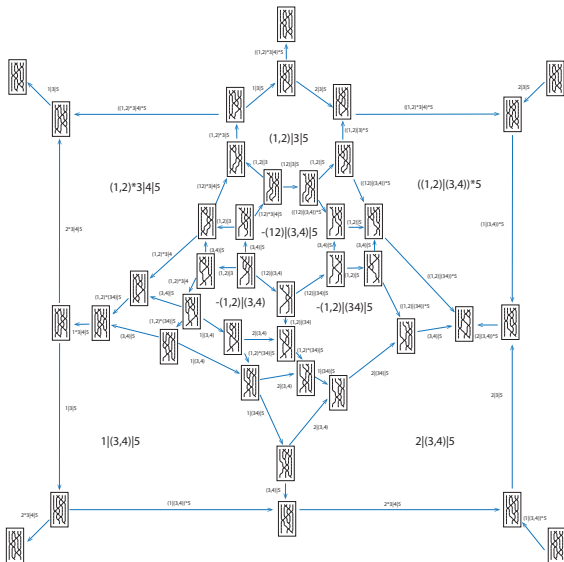

12|3|45

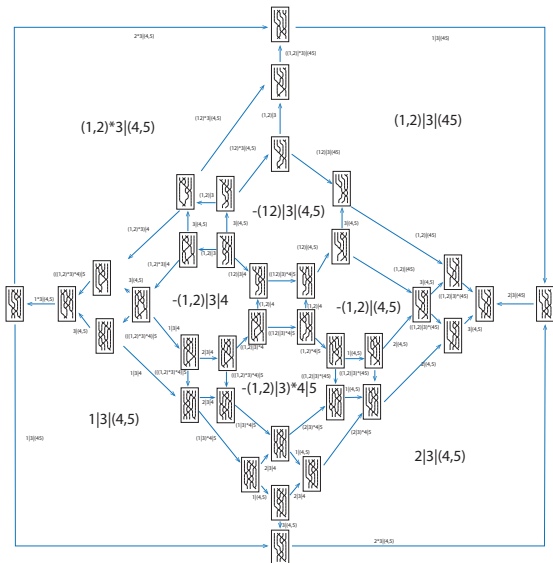

1|23|45

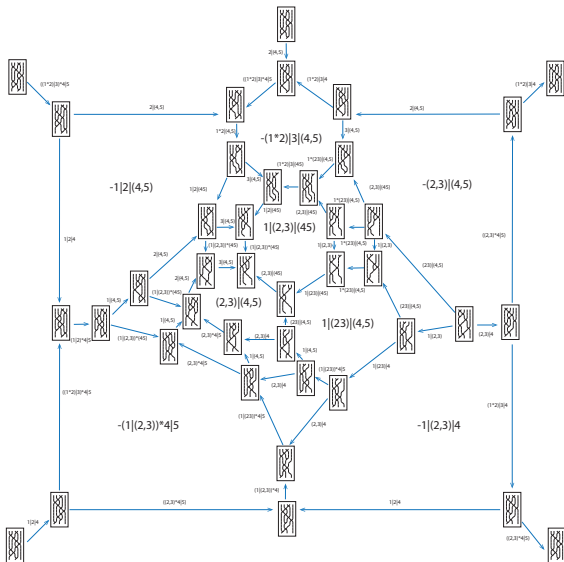

12|3|4|5

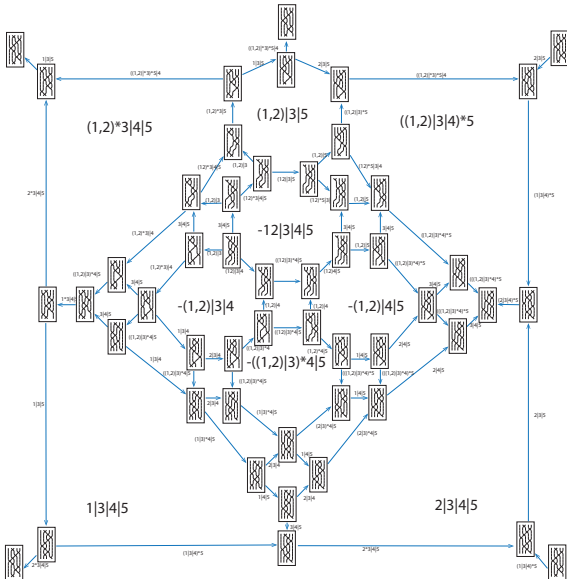

1|23|4|5

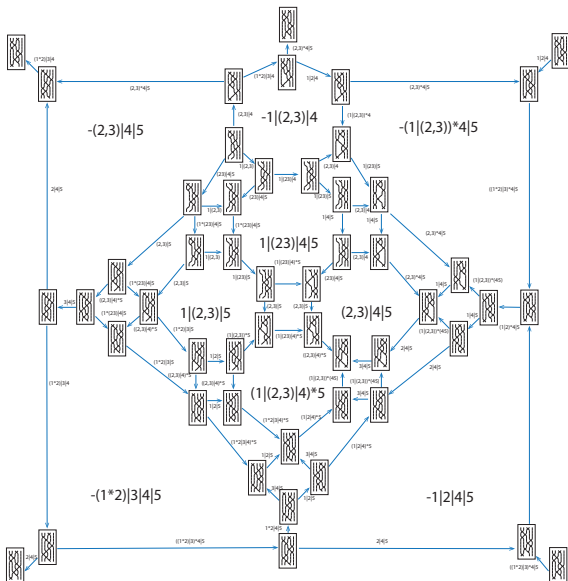

1|2|34|5

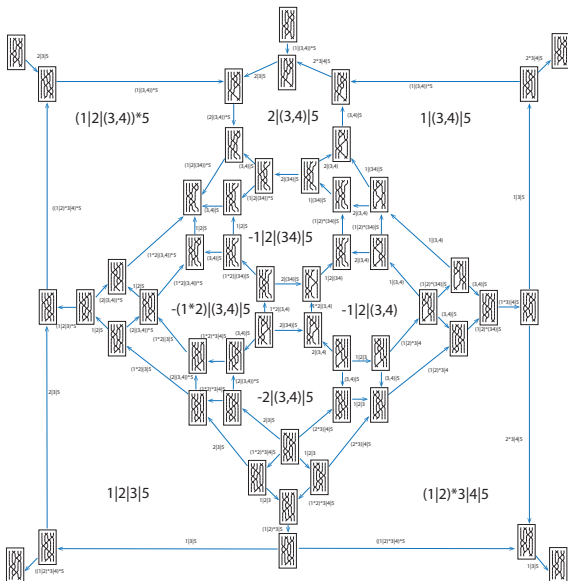

1|2|3|45

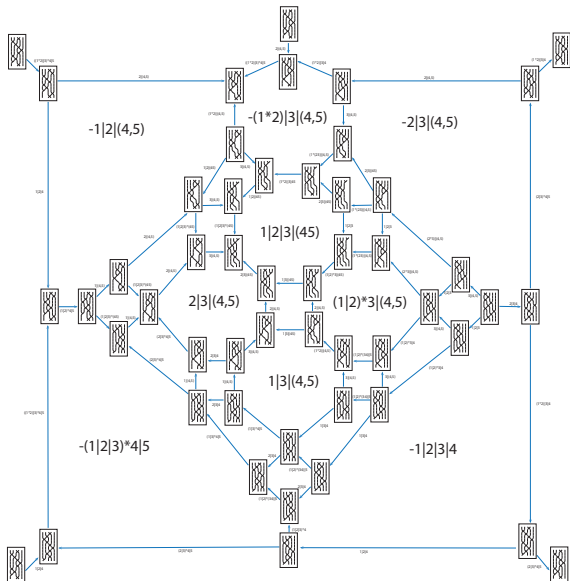

12345

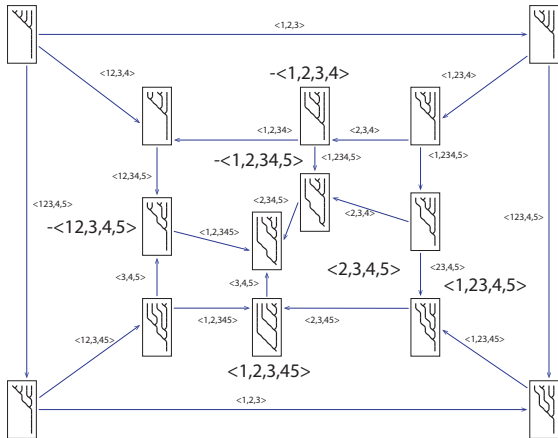

Section 5

in which the polytopal duals to the generating chains are formulated.

In this section, I am going to review something that is

In this section, I am going to review something that is (sort-of)

In this section, I am going to review something that is (sort-of) well-known.

In this section, I am going to review something that is (sort-of) well-known. Namely, the tetrahedral movie move

In this section, I am going to review something that is (sort-of) well-known. Namely, the tetrahedral movie move (quadruple point move)

In this section, I am going to review something that is (sort-of) well-known. Namely, the tetrahedral movie move (quadruple point move) (a CI move in Kamada's sense)

In this section, I am going to review something that is (sort-of) well-known. Namely, the tetrahedral movie move (quadruple point move) (a CI move in Kamada's sense) is dual to the permutahedron.

In this section, I am going to review something that is (sort-of) well-known. Namely, the tetrahedral move (quadruple point move) (a CI move in Kamada's sense) is dual to the permutahedron.

Permutahedron

In \mathbb{R}^n consider the convex hull of

$$\{(\sigma(1), \sigma(2), \dots, \sigma(n)) : \sigma \in \Sigma_n\}.$$

Permutahedron

In \mathbb{R}^n consider the convex hull of

$$\{(\sigma(1), \sigma(2), \dots, \sigma(n)) : \sigma \in \Sigma_n\}.$$

This is the set of vectors in \mathbb{R}^n with distinct coordinates taken from $\{1, 2, \dots, n\}$.

Permutahedron

In \mathbb{R}^n consider the convex hull of

$$\{(\sigma(1), \sigma(2), \dots, \sigma(n)) : \sigma \in \Sigma_n\}.$$

This is the set of vectors in \mathbb{R}^n with distinct coordinates taken from $\{1, 2, \dots, n\}$. Edges of the polytope can be labeled by adjacent transpositions:

$$\mathbf{i} = (i, i + 1).$$

Permutahedron

In \mathbb{R}^n consider the convex hull of

$$\{(\sigma(1), \sigma(2), \dots, \sigma(n)) : \sigma \in \Sigma_n\}.$$

This is the set of vectors in \mathbb{R}^n with distinct coordinates taken from $\{1, 2, \dots, n\}$. Edges of the polytope can be labeled by adjacent transpositions:

$i = (i, i + 1)$. Hexagonal faces are $i(i + 1)i(i + 1)i(i + 1)$.

Permutahedron

In \mathbb{R}^n consider the convex hull of

$$\{(\sigma(1), \sigma(2), \dots, \sigma(n)) : \sigma \in \Sigma_n\}.$$

This is the set of vectors in \mathbb{R}^n with distinct coordinates taken from $\{1, 2, \dots, n\}$. Edges of the polytope can be labeled by adjacent transpositions:

$\mathbf{i} = (i, i + 1)$. Hexagonal faces are $\mathbf{i}(\mathbf{i} + 1)\mathbf{i}(\mathbf{i} + 1)\mathbf{i}(\mathbf{i} + 1)$. *etc.*

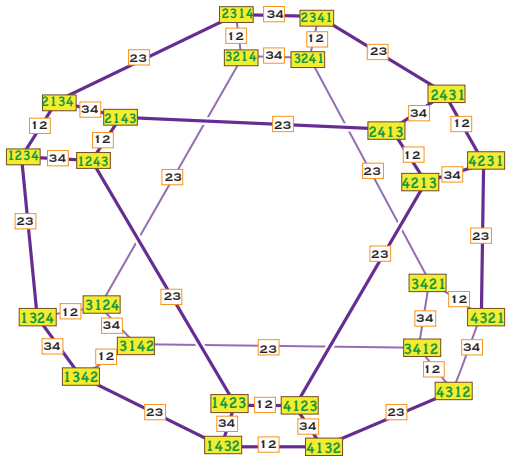

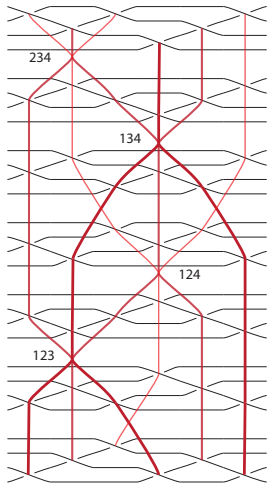
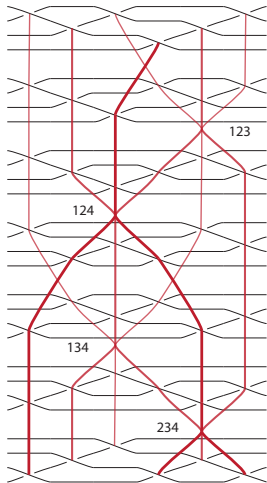

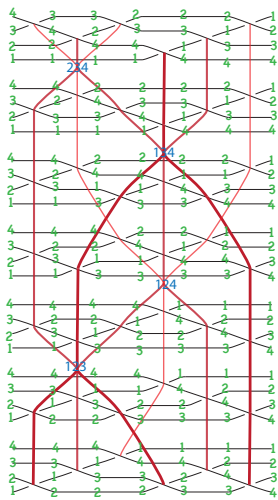
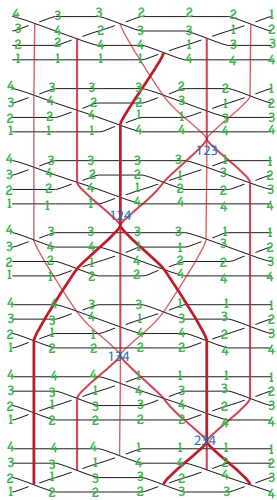

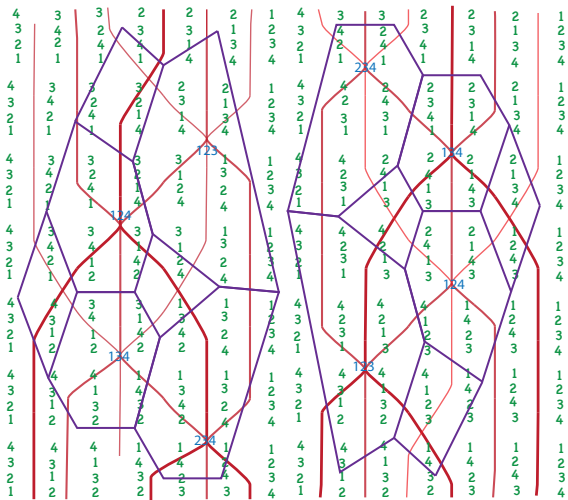

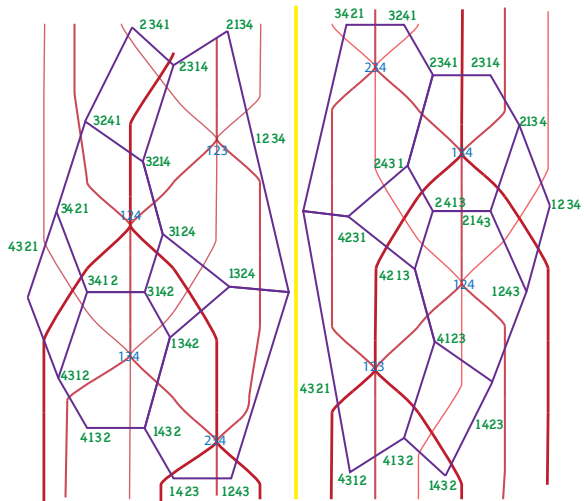

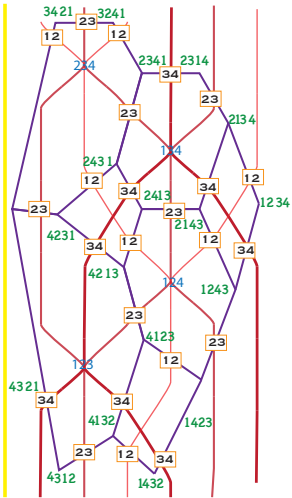
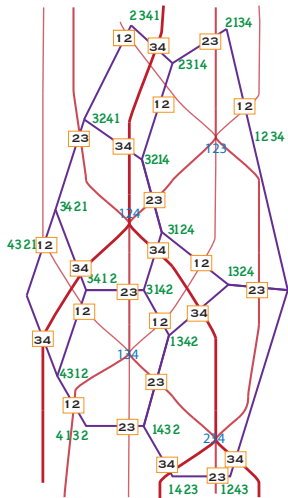

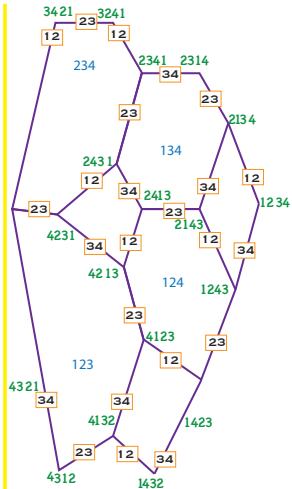
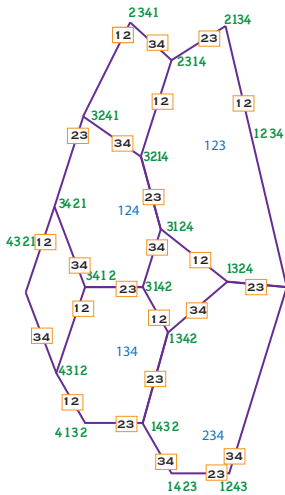

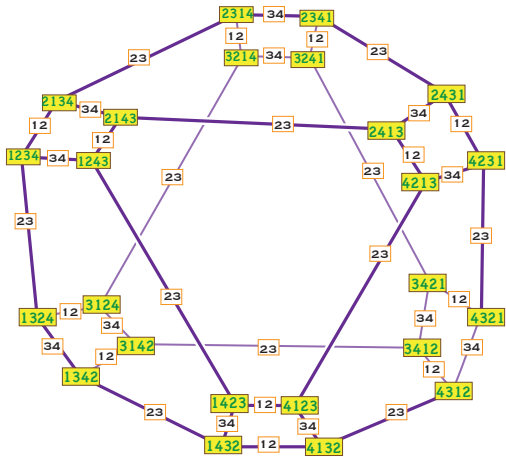

Ily

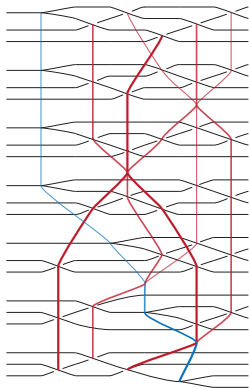

IY

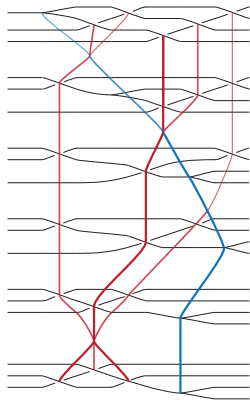

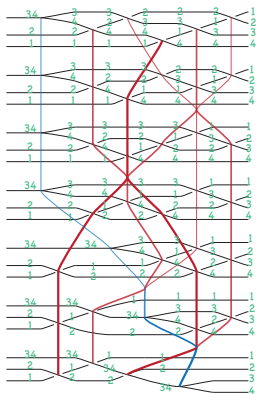

IIV

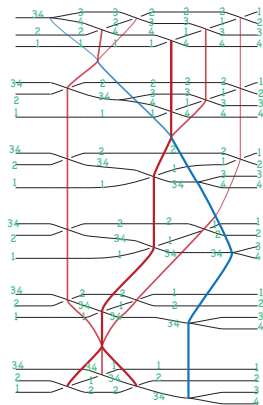

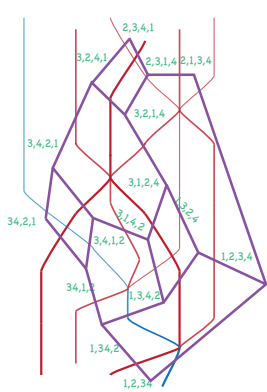

IY

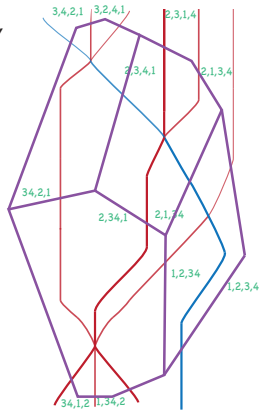

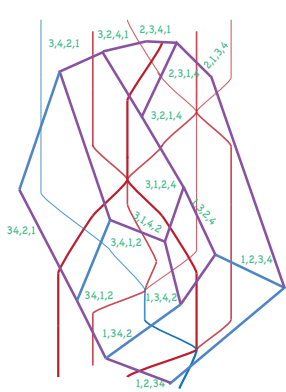

IY

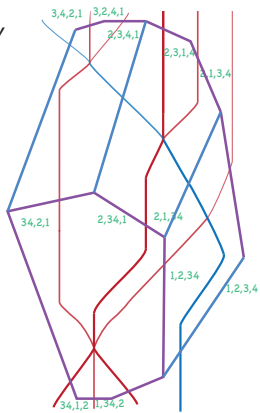

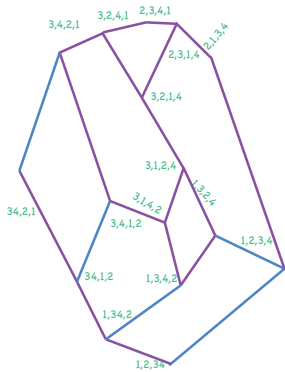

IY

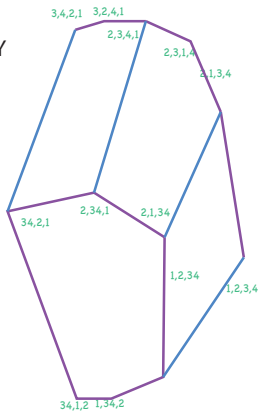

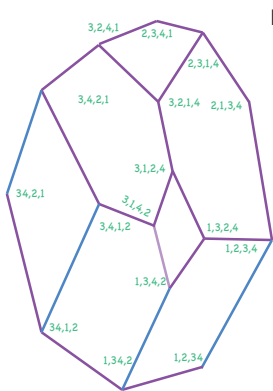

IY

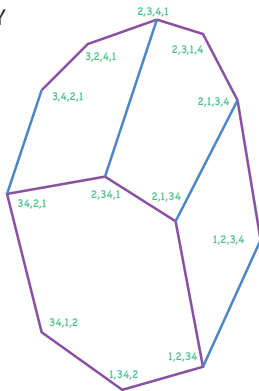

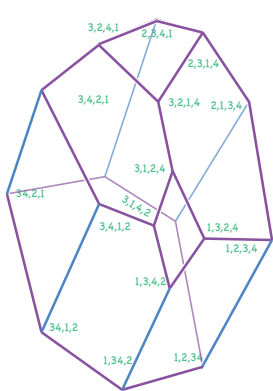

IY

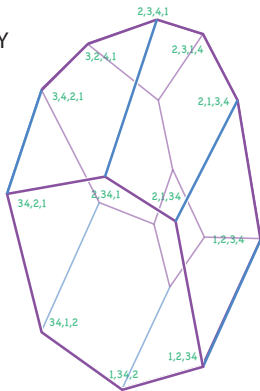

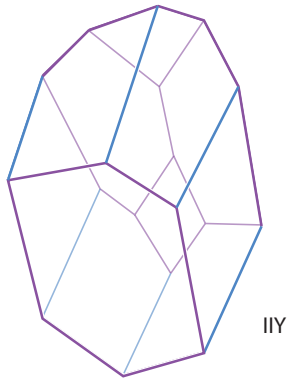

IIY

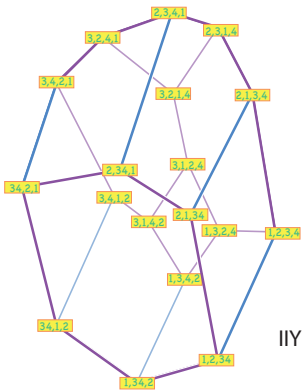

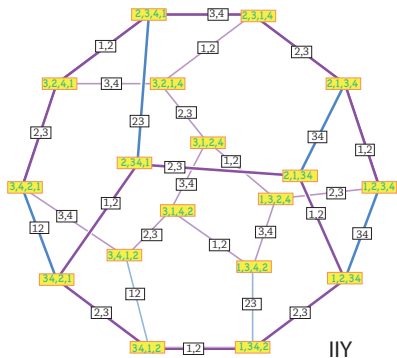

Before being in Asia, I thought that these polytopes were new.

Before being in Asia, I thought that these polytopes were new. But now I see that they are sold in the grocery store in Japan.

Before being in Asia, I thought that these polytopes were new. But now I see that they are sold in the grocery store in Japan.



YYY

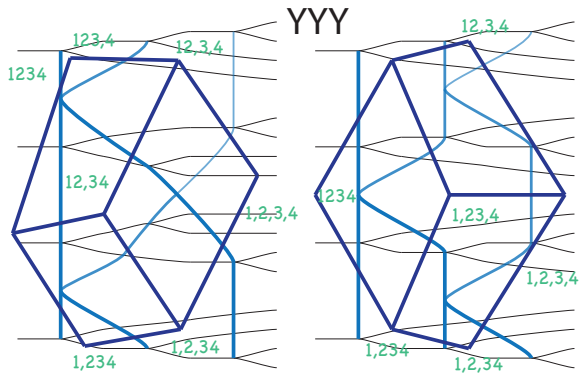

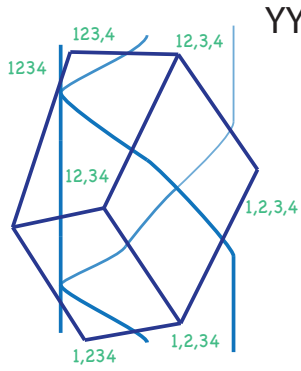

YYY

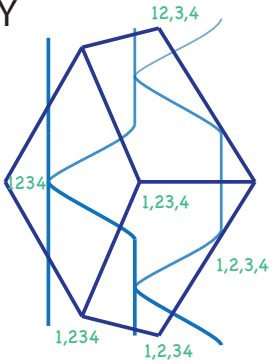

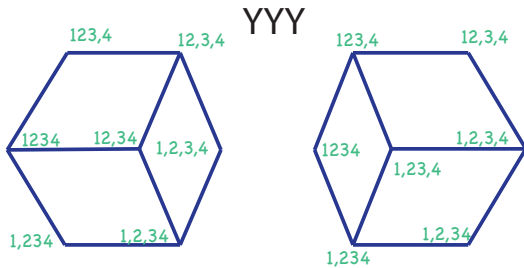

YYI

YYI

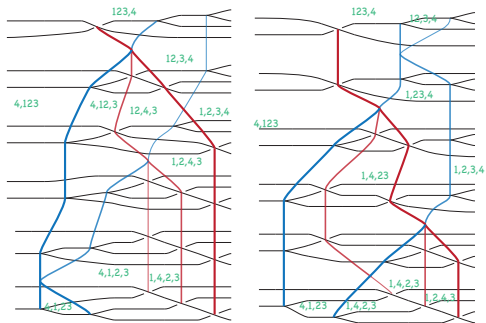

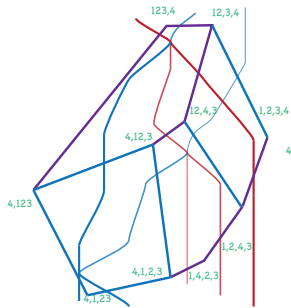

YYI

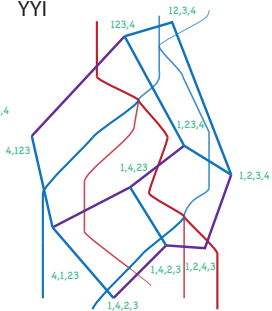

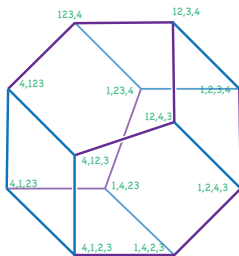

YYI

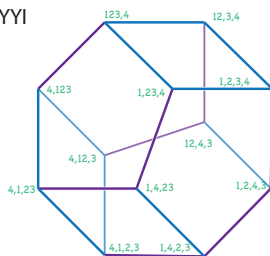

YYI

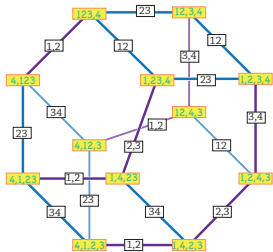

YII

YII

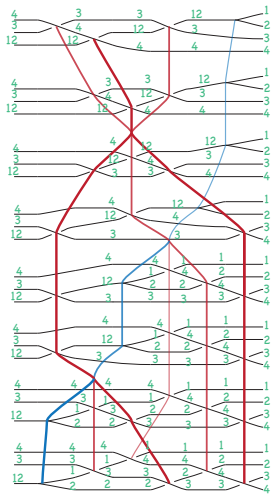
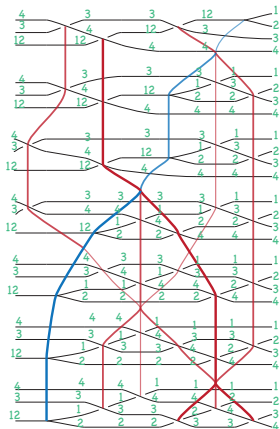

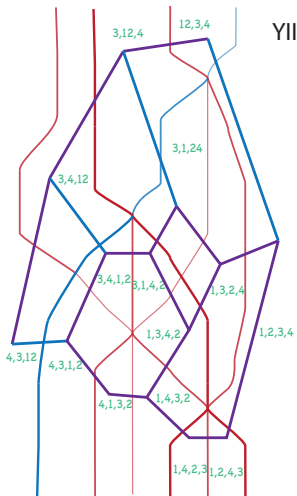

YII

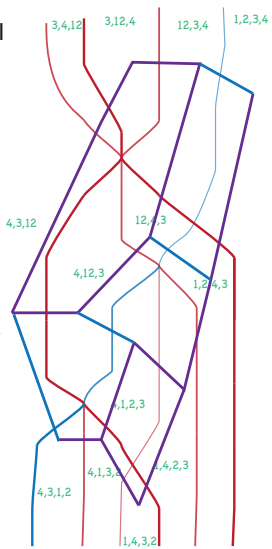

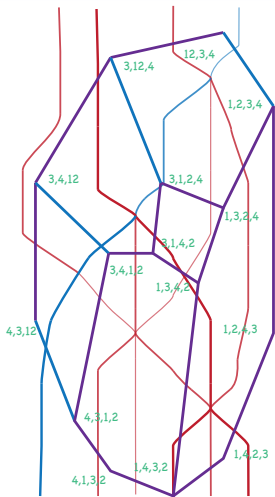

YII

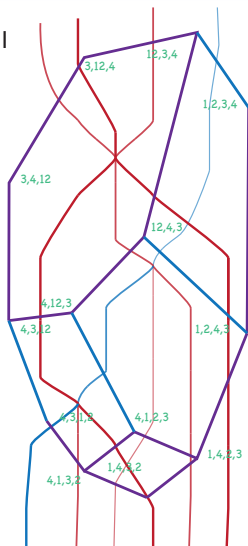

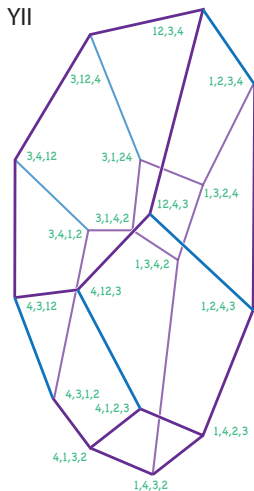
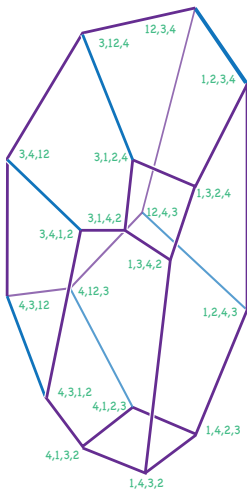

YII

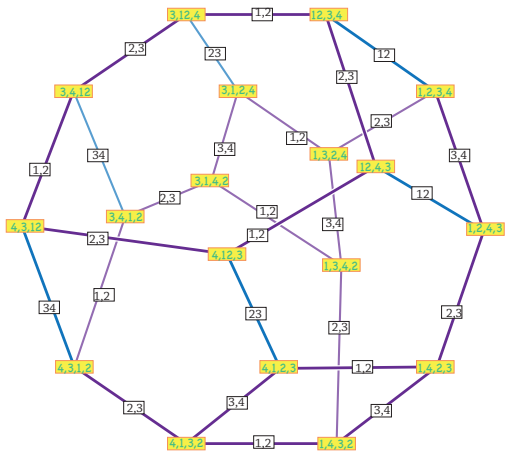

IYY

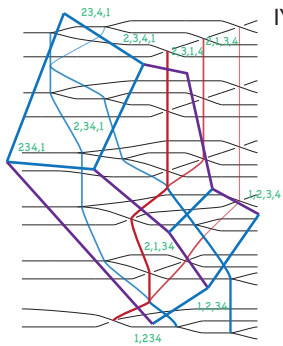

IYY

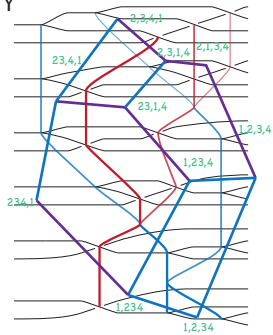

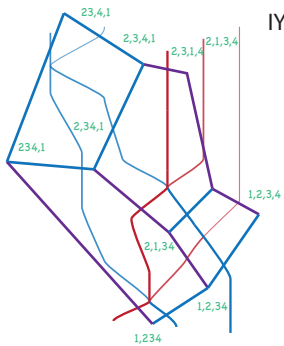

IYY

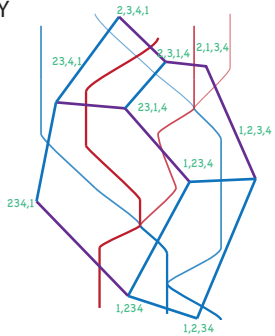

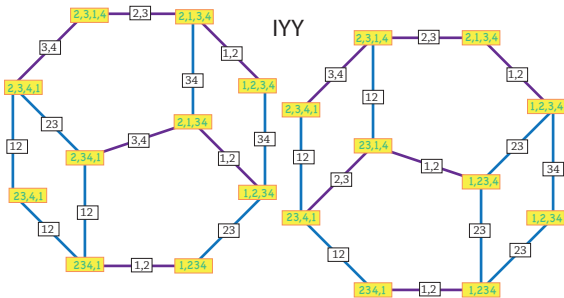

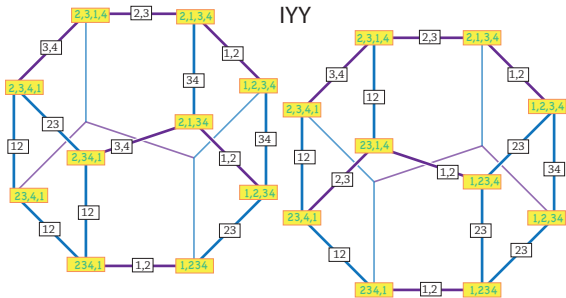

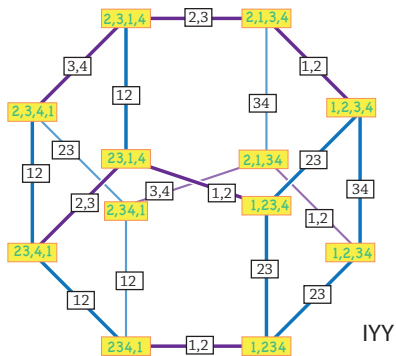

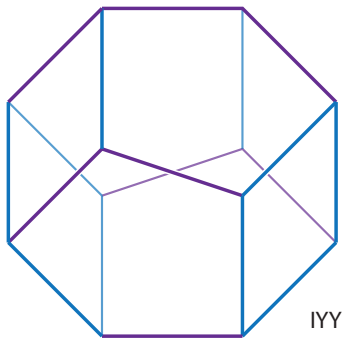

IYI

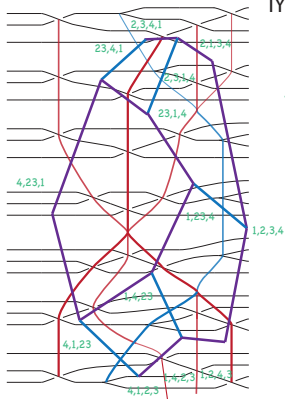

IV

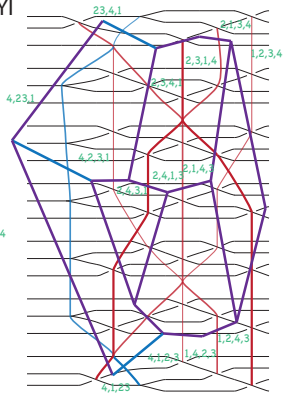

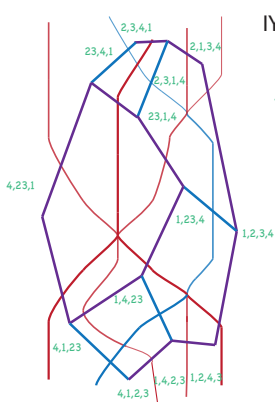

II

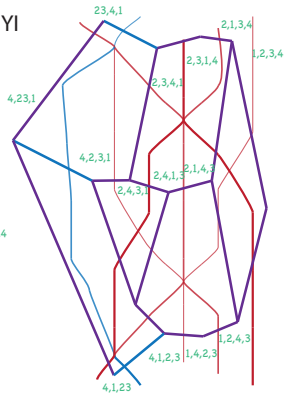

IVI

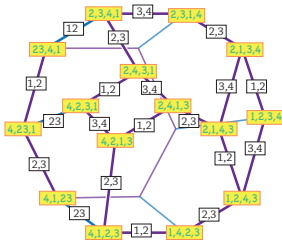
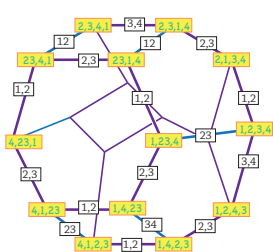

IV

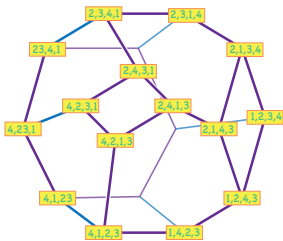
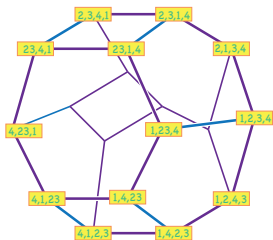

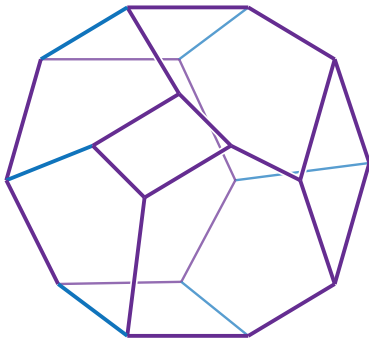

IYI

IYI

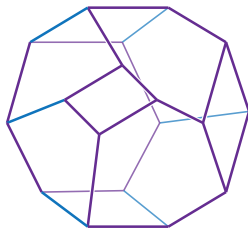
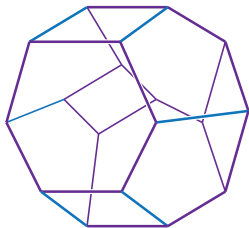

Ily

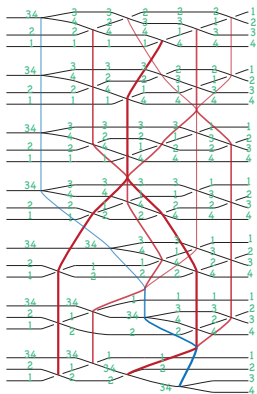

IY

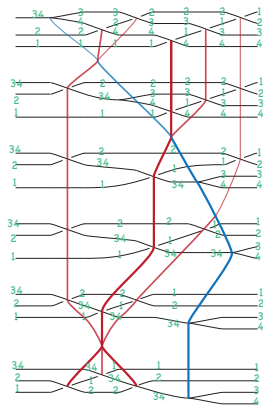

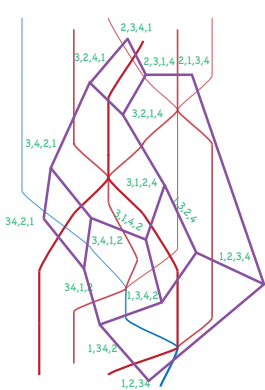

IY

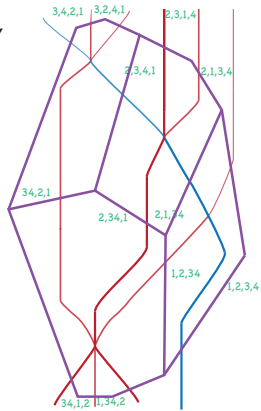

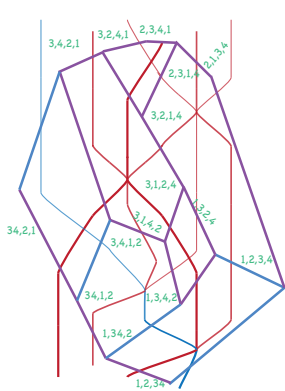

IY

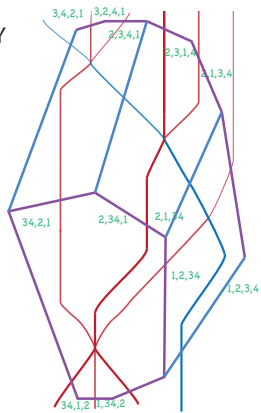

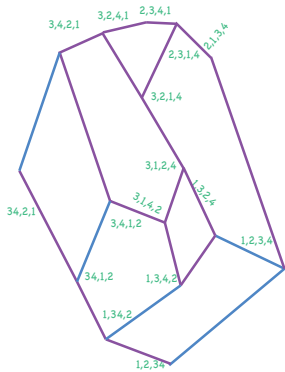

IY

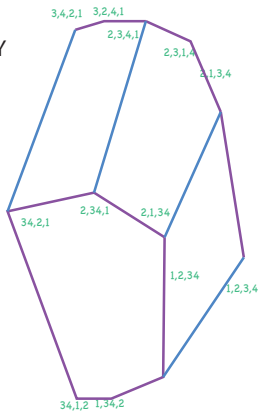

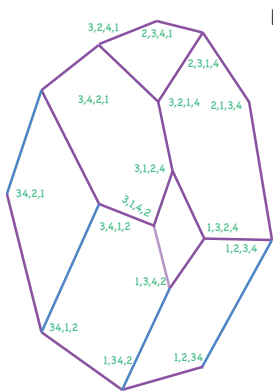

IY

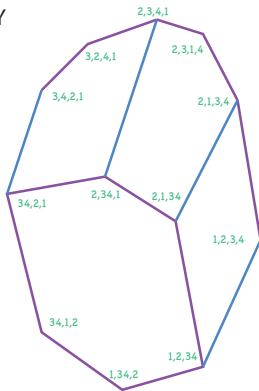

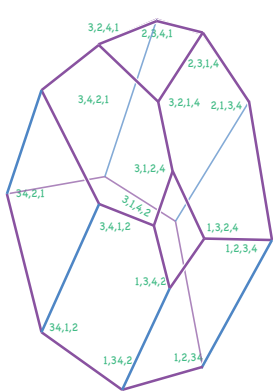

IY

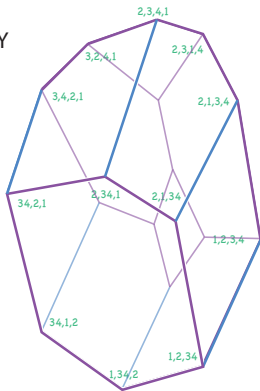

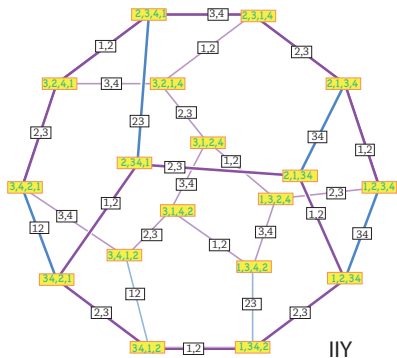

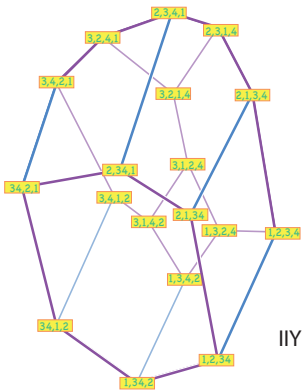

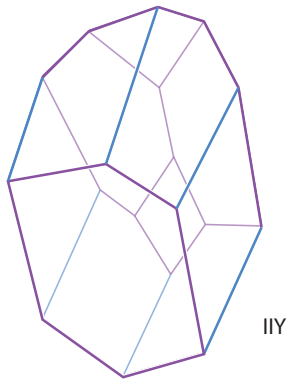

IY

IY

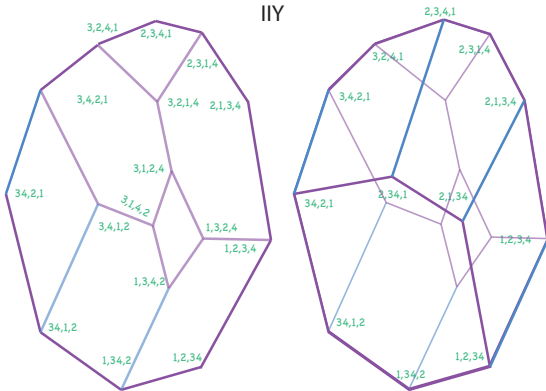

Next we'll use the graphical structure to formulate a series of Abstract tensor equations.

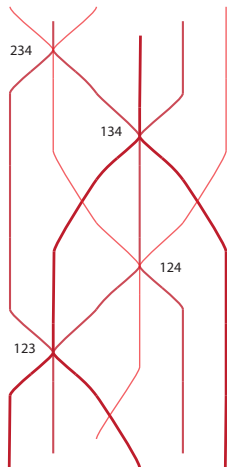
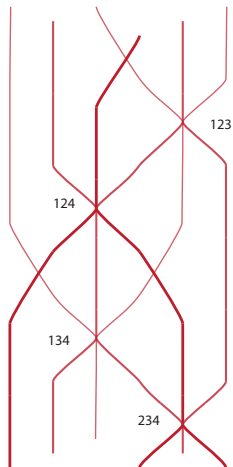

One of these equations is the Zamolodchikov tetrahedral equation.

$$S_{123}S_{124}S_{134}S_{234} = S_{234}S_{134}S_{124}S_{123}.$$

One of these equations is the Zamolodchikov tetrahedral equation.

$$S_{123}S_{124}S_{134}S_{234} = S_{234}S_{134}S_{124}S_{123}.$$

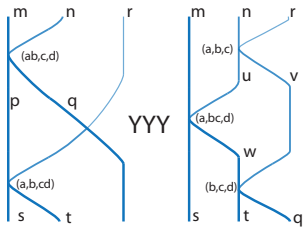

$$K_{p,q}^{m,n} K_{s,t}^{p,r} = K_{u,v}^{n,r} K_{s,w}^{m,u} K_{t,q}^{w,v}$$

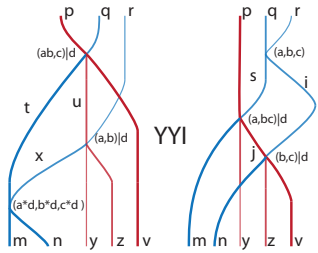

$$M_{t,u,v}^{p,q} M_{x,y,z}^{u,r} K_{m,n}^{t,x} = K_{s,i}^{q,r} M_{m,y,j}^{p,s} M_{n,z,v}^{j,i}$$

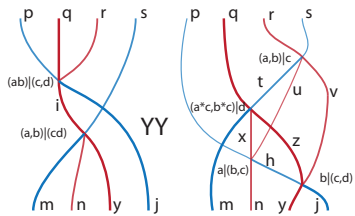

$$W_{ij}^{p,q,r} M_{m,n,y}^{i,s} = M_{t,u,v}^{r,s} M_{m,x,z}^{q,t} W_{n,h}^{p,x,u} W_{y,i}^{h,z,v}$$

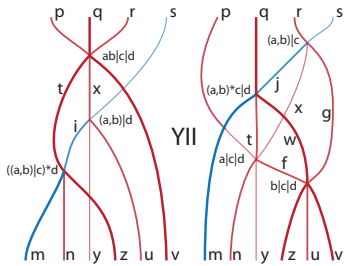

$$X_{t,x,u}^{p,q,r} M_{i,y,u}^{x,s} M_{m,n,z}^{t,i} = M_{j,x,g}^{r,s} M_{m,t,w}^{q,j} X_{n,y,f}^{p,t,x} X_{z,u,v}^{f,w,g}$$

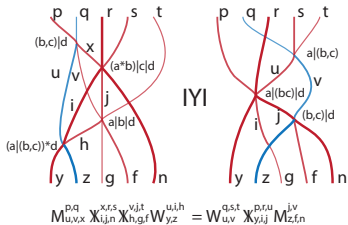
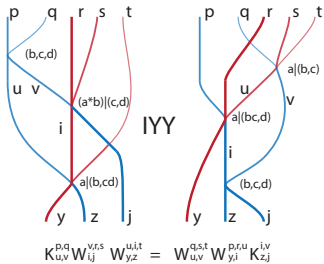

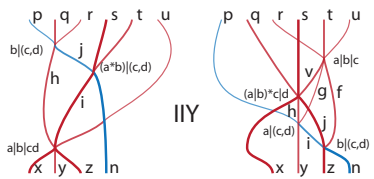

IIY

$$W_{hj}^{p,q,r} W_{in}^{i,s,t} X_{xy,z}^{h,i,u} = X_{v,g,f}^{r,t,u} X_{x,h,j}^{q,s,v} W_{y,i}^{p,h,g} W_{z,n}^{i,j,f}$$

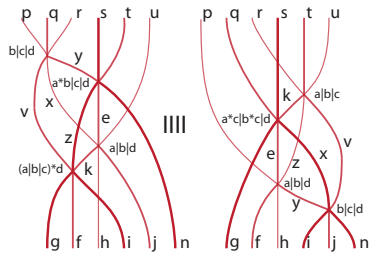

IIII

$$X_{v,x,y}^{p,q,r} X_{z,e,n}^{y,s,t} X_{k,h,j}^{x,e,u} X_{g,f,i}^{v,z,k} = X_{k,z,v}^{r,t,u} X_{g,e,x}^{q,s,k} X_{f,h,y}^{p,e,z} X_{i,j,n}^{y,x,v}$$

In 3-D

A	$Y_j^{\ell,n} Y_i^{j,k} = Y_p^{n,k} Y_i^{\ell,p}$
VI	$Y_d^{a,b} X_{e,f}^{d,c} = X_{c,h}^{b,c} X_{e,g}^{a,c} Y_f^{g,h}.$
IV	$X_{d,g}^{a,b} X_{h,f}^{g,c} Y_e^{d,h} = Y_i^{b,c} X_{e,f}^{a,i}$
III	$X_{d,e}^{a,b} X_{i,h}^{e,c} X_{f,g}^{d,i} = X_{j,k}^{b,c} X_{f,e}^{a,j} X_{g,h}^{e,k}$

$$Y_c^{a,b} = \begin{cases} 1 & \text{if } c = ab, \\ 0 & \text{otherwise;} \end{cases}$$

$$X_{c,d}^{a,b} = \begin{cases} 1 & \text{if } c = b \text{ \& } d = b^{-1}ab, \\ 0 & \text{otherwise.} \end{cases}$$

In 4-D

YYY	$K_{p,q}^{m,n} K_{s,t}^{p,r} = K_{u,v}^{n,r} K_{s,w}^{m,u} K_{t,q}^{w,v}$
YYI	$M_{t,u,v}^{p,q} M_{x,y,z}^{u,r} K_{m,n}^{t,x} = K_{s,i}^{q,r} M_{m,y,j}^{p,s} M_{n,z,v}^{j,i}$
YY	$W_{i,j}^{p,q,r} M_{m,n,y}^{i,s} = M_{t,u,v}^{r,s} M_{m,x,z}^{q,t} W_{n,h}^{p,x,u} W_{y,i}^{h,z,v}$
YII	$\mathbb{X}_{t,x,v}^{p,q,r} M_{y,u,v}^{x,s} M_{m,n,z}^{t,i} = M_{j,x,g}^{r,s} M_{m,t,x}^{q,j} \mathbb{X}_{n,y,f}^{p,t,x} \mathbb{X}_{z,u,v}^{f,w,g}$
IYY	$K_{u,v}^{p,q} W_{i,j}^{v,r,s} W_{y,z}^{u,i,t} = W_{u,v}^{q,s,t} W_{y,i}^{p,r,u} K_{z,j}^{i,v}$
IYI	$M_{u,v,x}^{p,q} \mathbb{X}_{i,j,n}^{x,r,s} \mathbb{X}_{h,g,f}^{v,j,t} W_{y,z}^{u,i,h} = W_{u,v}^{q,s,t} \mathbb{X}_{y,i,j}^{p,r,u} M_{z,f,n}^{j,v}$
IYY	$W_{h,j}^{p,q,r} W_{i,n}^{j,s,t} \mathbb{X}_{x,y,z}^{h,i,u} = \mathbb{X}_{v,g,f}^{r,t,u} \mathbb{X}_{x,h,j}^{q,s,v} W_{y,i}^{p,h,g} W_{z,n}^{i,j,f}$
IIII	$\mathbb{X}_{v,x,y}^{p,q,r} \mathbb{X}_{z,e,n}^{y,s,t} \mathbb{X}_{k,h,j}^{x,e,u} \mathbb{X}_{g,f,i}^{v,z,k} = \mathbb{X}_{k,z,v}^{r,t,u} \mathbb{X}_{g,e,x}^{q,s,k} \mathbb{X}_{f,h,y}^{p,e,z} \mathbb{X}_{i,j,n}^{y,x,v}$

$$K_{r,s}^{p,q} = \begin{cases} 1 & \text{if } \exists a, b, c \text{ s.t.} \\ & \begin{cases} p = ((ab, c), 0|0), & q = ((a, b), 0|0), \\ r = ((a, bc), 0|0), & \& s = ((b, c), 0|0). \end{cases} \\ 0 & \text{otherwise;} \end{cases}$$

$$M_{p,q,r}^{i,j} = \begin{cases} 1 & \text{if } \exists a, b, c \text{ s.t.} \\ & \begin{cases} i = ((0, 0), ab|c), & j = ((a, b), 0|0), \\ p = ((a, b) \triangleleft c, 0|0), & q = ((0, 0), a|c), \\ \& r = ((0, 0), b|c), \end{cases} \\ 0 & \text{otherwise;} \end{cases}$$

$$W_{p,q}^{i,j,\ell} = \begin{cases} 1 & \text{if } \exists a, b, c \text{ s.t.} \\ & \begin{cases} i = ((b, c), 0|0), & j = ((0, 0), (a \triangleleft b)|c), \\ \ell = ((0, 0), a|b), \\ p = ((0, 0), a|(bc)), & \& q = ((b, c), 0|0), \end{cases} \\ 0 & \text{otherwise;} \end{cases}$$

$$\chi_{s,t,u}^{p,q,r} = \begin{cases} 1 & \text{if } \exists a, b, c \text{ s.t.} \\ & \begin{cases} p = ((0, 0), b|c), & q = ((0, 0), (a \triangleleft b)|c), \\ r = ((0, 0), a|b), \\ s = ((0, 0), (a|b) \triangleleft c), & t = ((0, 0), a|c), \\ \& u = ((0, 0), b|c), \end{cases} \\ 0 & \text{otherwise;} \end{cases}$$

where, *e.g.*, $a \triangleleft c = c^{-1}ac$, $(a, b) \triangleleft c = (a \triangleleft c, b \triangleleft c)$,
and $(a|b) \triangleleft c = (a \triangleleft c)|(b \triangleleft c)$

These tensors form a solution set over a module whose basis is determined by the underlying algebraic structure precisely because $\partial \circ \partial = 0$ in the chain complex.

Thanks

Thank you for your attention!